

## Chapters SPS 320 to 325

## APPENDIX C

Section	Page	Section	Page
1 Wood preservatives for ground contact . . . . .	233	4 Alternate beam and joist spans. . . . .	243
2 Sources of design values . . . . .	236	5 Framing around a chimney or bay window. . . . .	245
3 Joist spans for alternate wood species. . . . .	237	6 Attachment of ledger boards to metal-plate- connected wood floor trusses. . . . .	246

**1. Wood preservatives for ground contact.** The following Table lists common pressure-preservative treatments and retention levels, in pounds per cubic foot, for sawn lumber in ground contact – based on the American Wood Protection Association’s *Book of Standards*.

**Table C–1**  
**PRESERVATIVE TREATMENTS AND RETENTION LEVELS FOR**  
**GROUND CONTACT (IN POUNDS PER CUBIC FOOT)**

Species	ACQ-B	ACQ-C	ACQ-D	CA-B	CuN-W
Southern Pine	0.40	0.40	0.40	0.21	0.11
Douglas Fir-Larch	0.40	0.40	NR	0.21	0.11
Hem-Fir	0.40	0.40	0.40	0.21	0.11
Ponderosa Pine	0.40	0.40	0.40	0.21	0.11
Red Pine	0.40	0.40	0.40	0.21	0.11
Spruce-Pine-Fir	NR <sup>1</sup>	0.40	NR	NR	NR
Redwood	NR	NR	NR	NR	NR

<sup>1</sup>NR = treatment not recommended.

**2. Sources of design values.** The sources of the design values in Appendix B are as follows:

Table 1 – Minimum footing sizes: The Building Inspectors Association of Southeast Wisconsin, December 2014.

Table 2 – Maximum post heights: *Typical Deck Details, Based on the 2009 International Residential Code*, Fairfax County, Virginia, July 2013.

Tables 3A and 3B – Maximum beam spans: *Design for Code Acceptance 6*, American Wood Council, May 2013.

Table 4 – Maximum joist spans: *Design for Code Acceptance 6 (DCA 6)*, American Wood Council, May 2013; except for the 2x6 values, which are from the Building Inspectors Association of Southeast Wisconsin, December 2014.

Table 5 – Minimum joist-hanger download capacity: *Design for Code Acceptance 6*, American Wood Council, May 2013; except for the 2x6 values, which are repeated from the 2x8 values.

Table 6 – Ledger-board-fastener spacing: *Design for Code Acceptance 6*, American Wood Council, May 2013.

Figure 29 – Stringer span length, and Table 7 – Minimum tread sizes: *Design for Code Acceptance 6*, American Wood Council, May 2013.

Table C–2 – Maximum joist spans for redwood, western cedars, ponderosa pine, and red pine: *Design for Code Acceptance 6*, American Wood Council, May 2013; except for the 2x6 values, which are from the Building Inspectors Association of Southeast Wisconsin, December 2014.  
Table C–3 – Trimmer joist download capacity: *Design for Code Acceptance 6*, American Wood Council, May 2013.

**3. Joist spans for alternate wood species.** The following Table lists maximum joist-span lengths for redwood, western cedars, ponderosa pine, and red pine.

**Table C–2**  
**MAXIMUM JOIST-SPAN LENGTH<sup>1</sup> FOR REDWOOD,**  
**WESTERN CEDARS, PONDEROSA PINE<sup>2</sup>, AND RED PINE<sup>2</sup>**

Joist Spacing (on center)	Joist Size	Without Overhang	With Overhangs
12"	2x6	8'-5"	7'-3"
	2x8	11'-8"	8'-6"
	2x10	14'-11"	12'-3"
	2x12	17'-5"	16'-5"
16"	2x6	7'-8"	7'-3"
	2x8	10'-7"	8'-6"
	2x10	13'-0"	12'-3"
	2x12	15'-1"	15'-1"
24"	2x6	6'-7"	6'-7"
	2x8	8'-8"	8'-6"
	2x10	10'-7"	10'-7"
	2x12	12'-4"	12'-4"

<sup>1</sup>Spans are based on 40 psf live load, 10 psf dead load, normal loading duration, wet service conditions and deflections of  $\Delta=L/360$  for main span and  $L/180$  for overhang with a 220-lb. point load.

<sup>2</sup>Design values based on northern species with no incising assumed.

**4. Alternate beam and joist spans.** The table on the following two pages lists alternate beam and joist spans and corresponding footing sizes from the Southeast Wisconsin Building Inspectors Association that can be used instead of the values in Appendix B.

Beam and Footing Sizes with Overhangs																																		
Based on No. 2 or better Southern Pine, Douglas Fir-Larch <sup>2</sup> , and Ponderosa Pine																																		
Joist Length (JL) <sup>1</sup>		Post Spacing (Measured Center to Center)																																
		4'	5'	6'	7'	8'	9'	10'	11'	12'	13'	14'																						
6'	Southern Pine Beam	1-2x6	1-2x6	1-2x8	2-2x6	2-2x8	2-2x8	2-2x10	2-2x10	2-2x12	3-2x10	3-2x12																						
	Douglas Fir-Larch Beam	1-2x6	1-2x8	1-2x8	2-2x8	2-2x8	2-2x10	2-2x10	2-2x12	2-2x12	3-2x10	3-2x12																						
	Ponderosa Pine Beam	1-2x6	1-2x8	1-2x8	2-2x8	2-2x8	2-2x10	2-2x10	2-2x12	2-2x12	3-2x10	3-2x12																						
	Corner Footing	8	7	6	9	8	7	10	8	7	11	9	8	11	9	8	12	10	9	12	10	9	13	11	9	14	11	10	14	12	10	15	12	10
	Intermediate Footing	10	8	7	11	9	8	12	10	9	13	11	9	14	12	10	15	12	11	15	13	11	16	13	12	17	14	12	17	14	13	18	15	13
Footing Thickness	6		6		6		6		6		6		6		6		6		6		6		6		6		8							

Published under s. 35.93, Stats. Updated on the first day of each month. Entire code is always current. The Register date on each page is the date the chapter was last published.

<b>Beam and Footing Sizes with Overhangs (Continued)</b>													
Based on No. 2 or better Southern Pine, Douglas Fir-Larch2, and Ponderosa Pine													
		<b>Post Spacing (Measured Center to Center)</b>											
<b>Joist Length (JL)<sup>1</sup></b>		<b>4'</b>	<b>5'</b>	<b>6'</b>	<b>7'</b>	<b>8'</b>	<b>9'</b>	<b>10'</b>	<b>11'</b>	<b>12'</b>	<b>13'</b>	<b>14'</b>	
<b>7'</b>	Southern Pine Beam	1-2x6	1-2x8	1-2x8	2-2x8	2-2x8	2-2x10	2-2x10	2-2x12	2-2x12	3-2x12	3-2x12	
	Douglas Fir-Larch Beam	1-2x6	1-2x8	2-2x6	2-2x8	2-2x8	2-2x10	2-2x10	2-2x12	3-2x10	3-2x12	3-2x12	
	Ponderosa Pine Beam	1-2x6	1-2x8	2-2x6	2-2x8	2-2x8	2-2x10	2-2x12	2-2x12	3-2x10	3-2x12	Eng Bm	
	Corner Footing	9   7   7	10   8   7	11   9   8	12   10   9	13   11   9	14   12   10	15   13   11	16   14   12	17   15   13	18   16   14	19   17   15	20   18   16
	Intermediate Footing	11   9   8	12   10   9	13   11   9	14   12   10	15   13   11	16   14   12	17   15   13	18   16   14	19   17   15	20   18   16	21   19   17	22   20   18
	Footing Thickness	6	6	6	6	6	6	6	6	6	8	8	8
<b>8'</b>	Southern Pine Beam	1-2x6	1-2x8	2-2x6	2-2x8	2-2x8	2-2x10	2-2x12	2-2x12	3-2x12	3-2x12	Eng Bm	
	Douglas Fir-Larch Beam	1-2x6	1-2x8	2-2x8	2-2x8	2-2x10	2-2x10	2-2x12	2-2x12	3-2x12	3-2x12	Eng Bm	
	Ponderosa Pine Beam	1-2x6	1-2x8	2-2x8	2-2x8	2-2x10	2-2x10	2-2x12	3-2x10	3-2x12	3-2x12	Eng Bm	
	Corner Footing	10   8   7	10   9   8	11   9   8	12   10   9	13   11   9	14   11   10	14   12   10	15   12   11	15   13   11	16   13   12	17   14   12	18   15   13
	Intermediate Footing	12   10   8	13   11   9	14   12   10	15   12   11	16   13   11	17   14   12	18   15   13	19   15   13	19   16   14	20   16   14	21   17   15	22   18   16
	Footing Thickness	6	6	6	6	6	6	8	8	8	8	8	8
<b>9'</b>	Southern Pine Beam	1-2x6	1-2x8	2-2x8	2-2x8	2-2x10	2-2x12	2-2x12	3-2x10	3-2x12	Eng Bm	Eng Bm	
	Douglas Fir-Larch Beam	1-2x8	1-2x8	2-2x8	2-2x8	2-2x10	2-2x12	2-2x12	3-2x12	3-2x12	Eng Bm	Eng Bm	
	Ponderosa Pine Beam	1-2x8	2-2x6	2-2x8	2-2x8	2-2x10	2-2x12	2-2x12	3-2x12	3-2x12	Eng Bm	Eng Bm	
	Corner Footing	10   8   7	11   9   8	12   10   9	13   11   9	14   11   9	14   12   10	15   12   11	16   13   11	16   13   12	17   14   12	18   14   13	19   15   13
	Intermediate Footing	12   10   9	14   11   10	15   12   11	16   13   11	17   14   12	18   15   13	19   15   13	20   16   14	20   17   15	21   17   15	22   18   16	23   19   17
	Footing Thickness	6	6	6	6	6	8	8	8	8	8	8	8
<b>10'</b>	Southern Pine Beam	1-2x6	1-2x8	2-2x8	2-2x8	2-2x10	2-2x12	2-2x12	3-2x12	3-2x12	Eng Bm	Eng Bm	
	Douglas Fir-Larch Beam	1-2x8	2-2x6	2-2x8	2-2x10	2-2x10	2-2x12	3-2x10	3-2x12	3-2x12	Eng Bm	Eng Bm	
	Ponderosa Pine Beam	1-2x8	2-2x6	2-2x8	2-2x10	2-2x10	2-2x12	3-2x10	3-2x12	Eng Bm	Eng Bm	Eng Bm	
	Corner Footing	10   9   8	12   10   8	12   10   9	13   11   10	14   12   10	15   12   11	16   13   11	16   14   12	17   14   12	18   15   13	18   15   13	19   16   14
	Intermediate Footing	13   11   9	14   12   10	15   13   11	17   14   12	18   15   13	19   15   13	20   16   14	21   17   15	21   18   15	22   18   16	23   19   17	24   20   18
	Footing Thickness	6	6	6	6	8	8	8	8	8	8	10	10
<b>11'</b>	Southern Pine Beam	1-2x8	2-2x6	2-2x8	2-2x10	2-2x10	2-2x12	3-2x12	3-2x12	Eng Bm	Eng Bm	Eng Bm	
	Douglas Fir-Larch Beam	1-2x8	2-2x8	2-2x8	2-2x10	2-2x10	2-2x12	3-2x12	3-2x12	Eng Bm	Eng Bm	Eng Bm	
	Ponderosa Pine Beam	1-2x8	2-2x6	2-2x8	2-2x10	2-2x12	2-2x12	3-2x12	3-2x12	Eng Bm	Eng Bm	Eng Bm	
	Corner Footing	11   9   8	12   10   9	13   11   9	14   12   10	15   12   11	16   13   11	16   14   12	17   14   12	18   15   13	19   15   13	19   16   14	20   17   15
	Intermediate Footing	13   11   10	15   12   11	16   13   12	17   14   12	19   15   13	20   16   14	21   17   15	22   18   15	22   18   16	23   19   17	24   20   17	25   21   19
	Footing Thickness	6	6	6	6	8	8	8	8	8	10	10	10
	Southern Pine Beam	1-2x8	2-2x6	2-2x8	2-2x10	2-2x12	2-2x12	3-2x12	3-2x12	Eng Bm	Eng Bm	Eng Bm	

Published under s. 35.93, Stats. Updated on the first day of each month. Entire code is always current. The Register date on each page is the date the chapter was last published.

<b>Beam and Footing Sizes with Overhangs (Continued)</b>												
Based on No. 2 or better Southern Pine, Douglas Fir-Larch2, and Ponderosa Pine												
		<b>Post Spacing (Measured Center to Center)</b>										
<b>Joist Length (JL)<sup>1</sup></b>		<b>4'</b>	<b>5'</b>	<b>6'</b>	<b>7'</b>	<b>8'</b>	<b>9'</b>	<b>10'</b>	<b>11'</b>	<b>12'</b>	<b>13'</b>	<b>14'</b>
<b>12'</b>	Douglas Fir-Larch Beam	1-2x8	2-2x8	2-2x8	2-2x10	2-2x12	3-2x10	3-2x12	3-2x12	Eng Bm	Eng Bm	Eng Bm
	Ponderosa Pine Beam	1-2x8	2-2x8	2-2x8	2-2x10	2-2x12	3-2x10	3-2x12	Eng Bm	Eng Bm	Eng Bm	Eng Bm
	Corner Footing	11 9 8	12 10 9	14 11 9	15 12 10	15 13 11	16 13 12	17 14 12	18 15 13	19 15 13	19 16 14	20 17 14
	Intermediate Footing	14 12 10	15 13 11	17 14 12	18 15 13	19 16 14	20 17 15	21 18 15	22 18 16	23 19 17	24 20 17	25 21 18
	Footing Thickness	6	6	6	8	8	8	8	8	10	10	10
<b>13'</b>	Southern Pine Beam	1-2x8	2-2x8	2-2x8	2-2x10	2-2x12	3-2x10	3-2x12	Eng Bm	Eng Bm	Eng Bm	Eng Bm
	Douglas Fir-Larch Beam	1-2x8	2-2x8	2-2x10	2-2x10	2-2x12	3-2x10	3-2x12	Eng Bm	Eng Bm	Eng Bm	Eng Bm
	Ponderosa Pine Beam	1-2x8	2-2x8	2-2x10	2-2x10	2-2x12	3-2x12	3-2x12	Eng Bm	Eng Bm	Eng Bm	Eng Bm
	Corner Footing	12 10 8	13 11 9	14 12 10	15 12 11	16 13 12	17 14 12	18 15 13	19 15 13	19 16 14	20 17 14	21 17 15
	Intermediate Footing	14 12 10	16 13 12	17 14 13	19 15 13	20 16 14	21 17 15	22 18 16	23 19 17	24 20 17	25 21 18	26 21 19
<b>14'</b>	Southern Pine Beam	1-2x8	2-2x8	2-2x8	2-2x10	2-2x12	3-2x12	3-2x12	Eng Bm	Eng Bm	Eng Bm	Eng Bm
	Douglas Fir-Larch Beam	1-2x8	2-2x8	2-2x10	2-2x10	2-2x12	3-2x12	3-2x12	Eng Bm	Eng Bm	Eng Bm	Eng Bm
	Ponderosa Pine Beam	1-2x8	2-2x8	2-2x10	2-2x12	2-2x12	3-2x12	Eng Bm	Eng Bm	Eng Bm	Eng Bm	Eng Bm
	Corner Footing	12 10 9	13 11 10	15 12 10	16 13 11	17 14 12	18 14 13	18 15 13	19 16 14	20 17 14	21 17 15	22 18 15
	Intermediate Footing	15 12 11	17 14 12	18 15 13	19 16 14	21 17 15	22 18 16	23 19 16	24 20 17	25 21 18	26 21 19	27 22 19
<b>15'</b>	Southern Pine Beam	1-2x8	2-2x8	2-2x10	2-2x12	2-2x12	3-2x12	3-2x12	Eng Bm	Eng Bm	Eng Bm	Eng Bm
	Douglas Fir-Larch Beam	2-2x6	2-2x8	2-2x10	2-2x12	2-2x12	3-2x12	Eng Bm	Eng Bm	Eng Bm	Eng Bm	Eng Bm
	Ponderosa Pine Beam	2-2x6	2-2x8	2-2x10	2-2x12	3-2x10	3-2x12	Eng Bm	Eng Bm	Eng Bm	Eng Bm	Eng Bm
	Corner Footing	12 10 9	14 11 10	15 12 11	16 13 12	17 14 12	18 15 13	19 16 14	20 16 14	21 17 15	22 18 15	22 18 16
	Intermediate Footing	15 13 11	17 14 12	19 15 13	20 17 14	21 18 15	23 19 16	24 20 17	25 21 18	26 21 19	27 22 19	28 23 20
<b>16'</b>	Southern Pine Beam	1-2x8	2-2x8	2-2x10	2-2x12	3-2x10	3-2x12	Eng Bm	Eng Bm	Eng Bm	Eng Bm	Eng Bm
	Douglas Fir-Larch Beam	2-2x6	2-2x8	2-2x10	2-2x12	3-2x10	3-2x12	Eng Bm	Eng Bm	Eng Bm	Eng Bm	Eng Bm
	Ponderosa Pine Beam	2-2x6	2-2x8	2-2x10	2-2x12	3-2x12	3-2x12	Eng Bm	Eng Bm	Eng Bm	Eng Bm	Eng Bm
	Corner Footing	13 11 9	14 12 10	15 13 11	17 14 12	18 15 13	19 15 13	20 16 14	20 17 15	21 18 15	22 18 16	23 19 16
	Intermediate Footing	16 13 11	18 15 13	19 16 14	21 17 15	22 18 16	23 19 17	25 20 18	26 21 18	27 22 19	28 23 20	29 24 21
Footing Thickness	6	8	8	8	8	10	10	10	10	12	12	

Notes:

**Published under s. 35.93, Stats. Updated on the first day of each month. Entire code is always current. The Register date on each page is the date the chapter was last published.**

1. Joist Length ( $J_L$ ) is Joist Span ( $L_j$ ) plus any cantilever at the beam that is being sized.
2. Incising assumed for refractory species Douglas Fir-Larch.
3. All footing sizes above are base diameters (in inches) and are listed for THREE SOIL CAPACITIES. Soil capacity is based on the requirements of State of Wisconsin SPS 321.15 (3).<sup>4</sup>
4. For square footings, insert the diameter (d) into the following formula:  $\sqrt{((d/2)^2 \times \pi)}$ . This number will give you the square dimension and shall be rounded up to the nearest inch.

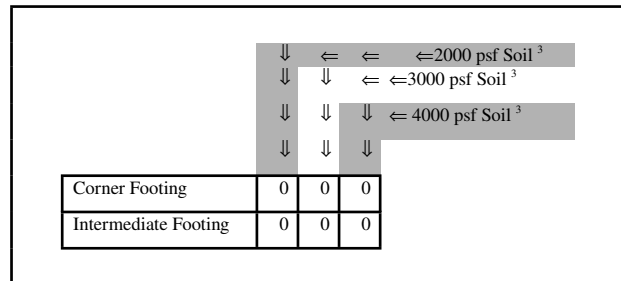

Corner Footing	0	0	0
Intermediate Footing	0	0	0

**5. Framing around a chimney or bay window.** All members at a chimney or bay window must be framed in accordance with Figure C-1. Headers may span a maximum of 6'-0". Where a chimney or bay window is wider than 6'-0", one or more 6x6 posts may be added to reduce header spans to less than 6'-0". In such cases, the post footing must meet the requirements in section 2 of Appendix B. Plan submittal and approval is required for headers with a span length greater than 6'-0". Headers must be located no more than 3'-0" from the end of the trimmer joist.

Triple trimmer joists are required on each side of the header if joist spacing is 12" or 16" on center or if the trimmer joist span exceeds 8'-6"; otherwise, double trimmer joists are permitted. Trimmer joists may bear on the beam and extend past the beam centerline up to  $L_j/4$  as shown in Figures 5 and 7 in Appendix B, or the trimmer joist may attach to the side of the beam with joist hangers as shown in Figure 6 in Appendix B. Joist hangers must each have a minimum download capacity in accordance with Table C-3. Bolts or lag screws used to attach the hanger to the ledger must fully extend through the ledger into the 2-inch nominal lumber band joist (1 1/2" actual) or the EWP rim board. See Figure 15 in Appendix B for fastener spacing, and edge and end distances. Otherwise a free-standing deck is required.

**Figure C-1**  
**DETAIL FOR FRAMING AROUND A CHIMNEY OR BAY WINDOW**

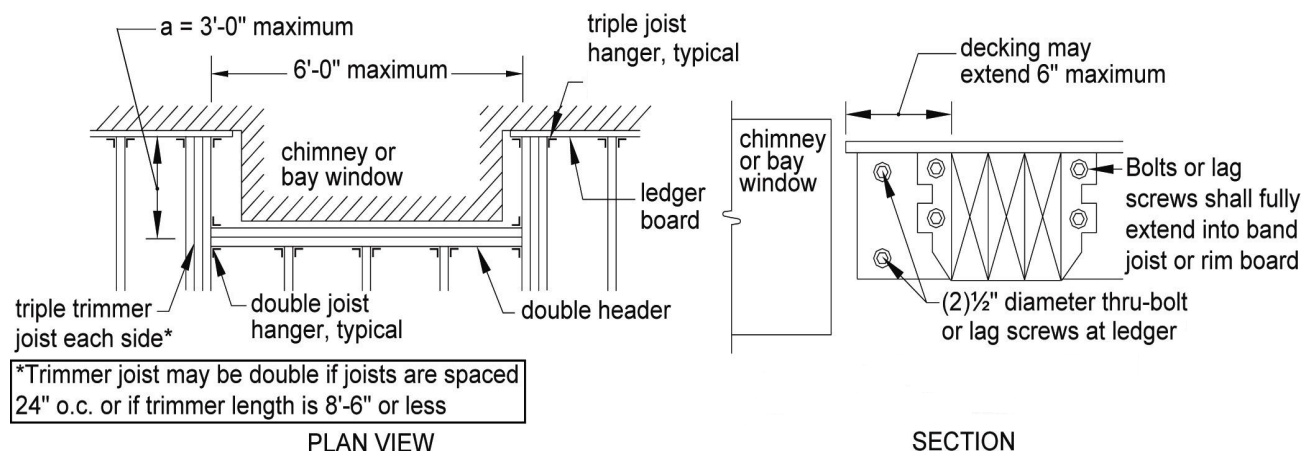

**Table C-3**  
**TRIMMER JOIST HANGER DOWNLOAD CAPACITY**

Joist Size	Minimum Capacity, lbs
2x8	1050
2x10	1380
2x12	1500

**6. Attachment of ledger boards to metal-plate-connected wood floor trusses.** The research report on the following pages shows acceptable methods for attaching a ledger board to a metal-plate-connected wood-floor-truss system.

# **Attachment of Residential Deck Ledger to Metal Plate Connected Wood Truss Floor System**

SRR No. 1408-01

Prepared for SBCA

## **Report Written by:**

Jim Vogt, P.E.

October 1, 2014

## Table of Contents

<b>Introduction</b> .....	<b>264</b>
<b>Key Definitions</b> .....	<b>264</b>
<b>Background</b> .....	<b>264</b>
<b>Application</b> .....	<b>265</b>
<b>Installation</b> .....	<b>265</b>
<b>Findings</b> .....	<b>272</b>
<b>References and Substantiating Data</b> .....	<b>272</b>

### Introduction:

This research report provides construction details for residential deck ledger attachment to metal plate connected wood truss floor systems. The applicable codes and standards follow the *2009* and *2012 International Building Code (IBC)* and the *2009* and *2012 International Residential Code (IRC)*. Proper attachment of the deck ledger to the house is critical for ensuring that an “attached” deck is safely and securely supported at this location. This report provides details for attaching a 2” nominal lumber deck ledger to residential floor systems constructed with metal plate connected wood (MPCW) floor trusses.

### Key Definitions:

**Deck Ledger** – A horizontal lumber beam attached to an existing wall and used to tie in construction elements such as porch roofs and decks. A deck ledger is installed as part of the deck frame construction and supports one end of the deck joists.

**Truss** – An engineered structural component, assembled from wood members, metal connector plates and other mechanical fasteners, designed to carry its own weight and superimposed design loads. The truss members form a semi-rigid structural framework and are assembled such that the members form triangles.

**Wood Structural Panel (WSP)** – A panel manufactured from wood veneers, strands or wafers or a combination of veneer and wood strands or wafers bonded together with waterproof synthetic resins or other suitable bonding systems. Examples include: plywood, Oriented Strand Board (OSB), waferboard and composite panels.

### Background:

The *2009* and *2012 IRC* include prescriptive provisions for attaching a 2” nominal lumber deck ledger to a 2” nominal lumber band joist bearing directly on a sill plate or wall plate using 1/2”-diameter bolts or lag screws. AF&PA’s American Wood Council, in cooperation with the International Code Council, has also developed *Design for Code Acceptance No. 6 (DCA6) – Prescriptive Residential Deck Construction Guide*, available at [awc.org](http://awc.org).

The prescriptive provisions for the deck ledger connection to the band joist in the *IRC* and *DCA6* are based on the results from a series of ultimate load tests conducted at Virginia Polytechnic Institute and State University (VT) Department of Wood Science and Forest Products, and Washington State University (WSU) Wood Materials and Engineering Laboratory. This testing evaluated the capacity 2” nominal pressure-preservative-treated (PPT) Hem-Fir (HF) and Southern Pine (SP) ledgers attached to either 2” nominal Spruce-Pine-Fir (SPF) or 1” net Douglas-Fir (DF) laminated veneer lumber (LVL) band joists, through 1<sup>5</sup>/<sub>32</sub>”-thick oriented strand board (OSB) sheathing, with 1/2”-diameter hot-dipped galvanized (HDG) bolts or lag screws, meeting the requirements of *ANSI/ASME Standard B18.2.1*.



The deck ledger assemblies evaluated at VT and WSU were deemed to represent commonly accepted means of connecting deck ledgers to band joists that cannot be evaluated using the provisions of the *National Design Specification® for Wood Construction (NDS®)* because:

1. The ledger is not in direct contact with the band joist (i.e., separated by  $15/32$ " OSB sheathing).
2. The minimum required penetration depth of four diameters (4D) is not met when using  $1/2$ "-diameter lag screws into an  $1\frac{1}{2}$ "-thick band joist.

### Application:

The details and fastener spacing tables provided in this report for connecting a 2" nominal lumber deck ledger to a residential floor system constructed with MPCW trusses use a single shear reference lateral design value, Z, of 710 lbs. for a  $1/2$ "-diameter bolt and 375 lbs. for a  $1/2$ " x 6" lag screw. These lateral design values were developed from the VT and WSU testing, and assume the fasteners are installed in accordance with the *NDS* requirements for clearance holes, lead holes, edge distance and end distance.

Detail 1 includes construction information for attaching 2" nominal lumber deck ledgers to the ends of MPCW floor trusses spaced no more than 24" o.c. Table 1 provides the maximum on-center spacing for each  $1/2$ "-diameter bolt or  $1/2$ " x 6" lag screw used to attach the ledger to the floor truss system for deck joist spans up to 18', assuming a design deck load of 40 psf live load (or 40 psf snow load) and 10 psf dead load. Table 2 includes similar information as Table 1, except for a design deck load of 60 psf live load (or 60 psf snow load) and 10 psf dead load.

Detail 2 includes construction information for attaching 2" nominal lumber deck ledgers to the side of a MPCW floor ladder frame with 4x4 vertical webs spaced no more than 16" o.c. provides the maximum on-center spacing for each  $1/2$ "-diameter bolt and  $1/2$ " x 6" lag screw used to attach the ledger to the ladder frame for deck joist spans up to 18', assuming a design deck load of 40 psf live load (or 40 psf snow load) and 10 psf dead load. Table 4 includes similar information as Table 3, except for a design deck load of 60 psf live load (or 60 psf snow load) and 10 psf dead load.

Detail 3 includes deck lateral load connection options capable of resisting the 1500 lbf lateral load requirement specified in 2009 and 2012 IRC Section 507.

Support of concentrated loads from deck beams of girders are beyond the scope of this report. Deck ledgers shall not be supported on stone or masonry veneer.

### Installation:

The following is a summary of the minimum requirements and limitations for installing a 2" nominal lumber deck ledger with residential floor systems constructed with MPCW floor trusses.

1. Ledger must be 2x10 or 2x12 PPT or code-approved decay-resistant lumber with a specific gravity,  $G \geq 0.43$ . Ledger shall be identified by the grade mark of, or certificate of inspection issued by, an approved lumber grading or inspection bureau or agency. PPT material must be pressure-treated with an approved process in accordance with American Wood Protection Association standards
2. Install ledger directly over wood structural sheathing ( $15/32$ " maximum thickness) fastened to the wall per the building code.
3. Attach ledger through wood structural sheathing into 2-ply 2x4 truss end vertical, 4x4 vertical web or key-block with  $1/2$ " x 6" lag screws or  $1/2$ "-diameter bolts with washers and nuts.
  - .1 Only one (1) fastener into each truss member or key-block.
  - .2 Install each fastener through the centerline of the truss member or key-block and position so as not to interfere with bottom and top chord joints and connector plates. Refer to Detail 1 and Detail 2 for spacing requirements
  - .3 Lag screws and bolts shall be installed according to 2005 *NDS* requirements. A "test" installation is recommended before drilling the lead holes, to ensure that the lead holes are neither too small nor too large.
    - 1/2" x 6" lag screws:

Lead holes for the threaded portion shall be  $\frac{5}{16}$ ".

Clearance holes shall be  $\frac{1}{2}$ " and the same depth of penetration as the length of unthreaded shank.

$\frac{1}{2}$ " -diameter bolts:

Holes shall be a minimum of  $\frac{17}{32}$ " to a maximum of  $\frac{9}{16}$ ".

All fasteners used with PPT wood shall be hot-dip zinc-coated galvanized steel, stainless steel, silicon bronze, or copper. Fasteners to be hot-dipped galvanized shall meet the requirements of *ASTM A153 – Standard Specification for Zinc Coating (Hot-Dip) on Iron and Steel Hardware*, Class D, for fasteners  $\frac{3}{8}$ " diameter and smaller or Class C for fasteners with diameters over  $\frac{3}{8}$ ". Lag screws, bolts, nuts and washers are permitted to be mechanically deposited zinc-coated steel with coating weights in accordance with *ASTM B695*, Class 55, minimum.

All hardware (e.g., joist hangers, hold-down devise, etc.) shall be galvanized or shall be stainless steel. Hardware to be hot-dipped prior to fabrication shall meet *ASTM A653 – Standard Specification for Steel Sheet, Zinc-Coated (Galvanized) or Zinc-Iron Alloy-Coated (Galvannealed) by the Hot-Dip Process*, G-185 coating. Hardware to be hot-dipped galvanized after fabrication shall meet *ASTM A123 – Specification for Zinc (Hot-Dip Galvanized) Coatings on Iron and Steel Products*.

Fasteners and hardware exposed to saltwater or located within 300' of a salt water shoreline shall be stainless steel grade 304 or 316.

Fasteners and hardware shall be of the same corrosion-resistant material.

Other coated or non-ferrous fasteners or hardware shall be as approved by the authority having jurisdiction.

4. Install flashing at top of ledger for water tightness. Flashing shall be corrosion-resistant metal of minimum nominal 0.019" thickness or an approved non-metallic material. Do not use aluminum flashing in direct contact with lumber treated with preservatives containing copper, such as ACQ, Copper Azole or ACZA.
5. Two-ply 2x4 truss end verticals, 4x4 truss vertical webs and key-blocks connected to ledger with lag screws or bolts shall have a specific gravity, G = 0.42 (includes DF, HF, SP and SPF).

Construct key-blocks with minimum 2x4 No. 2 or better lumber.

Install key-blocks at required locations. Cut to fit tight.

Refer to Detail 1 and Detail 2 for additional information concerning key-block construction and attachment.

**WALL SECTION**

NOTE - EXTERIOR CLADDING AND FLASHING NOT SHOWN FOR CLARITY.

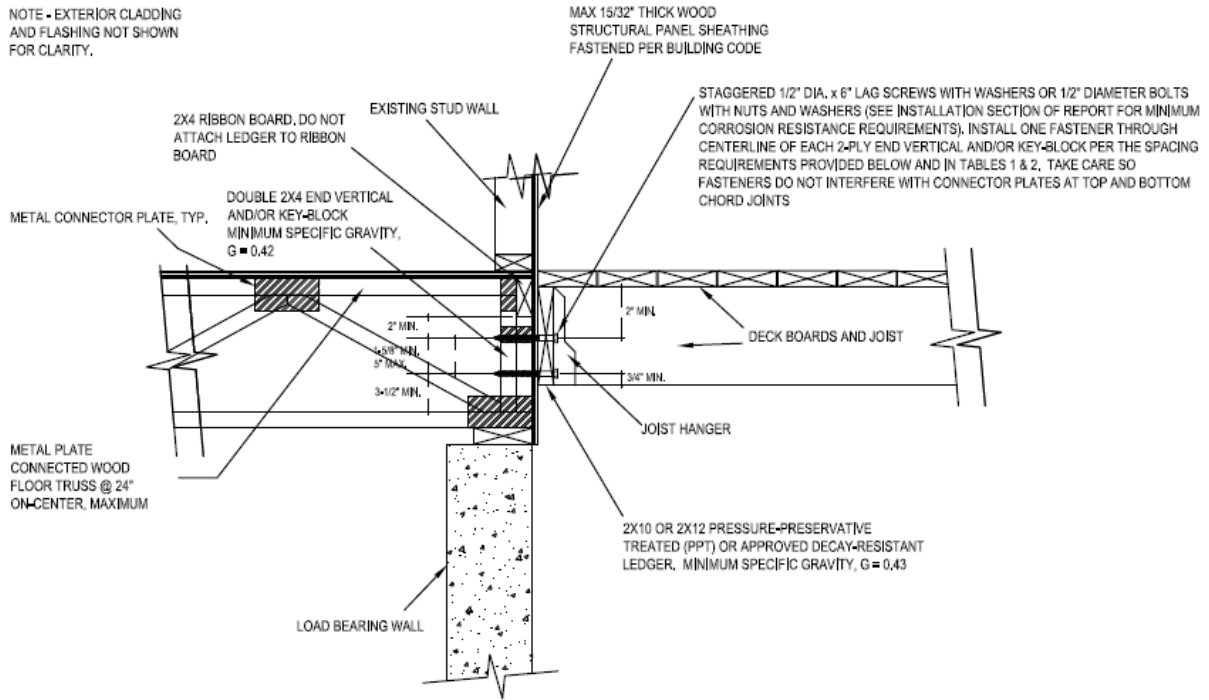

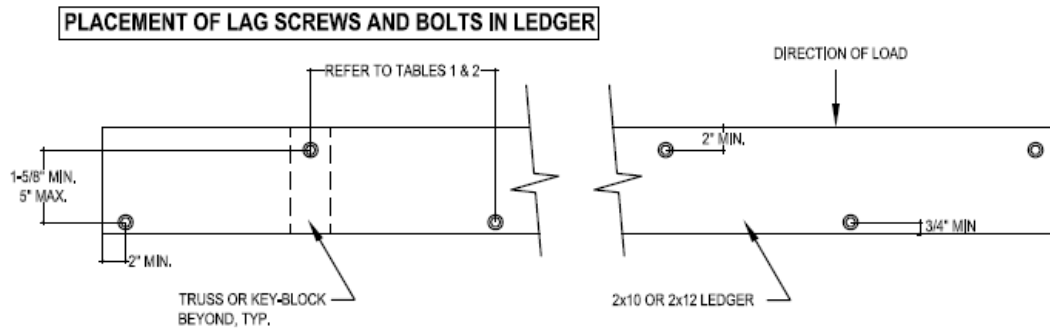

**KEY-BLOCK DETAIL FOR LEDGER ATTACHED TO END OF TRUSSES**

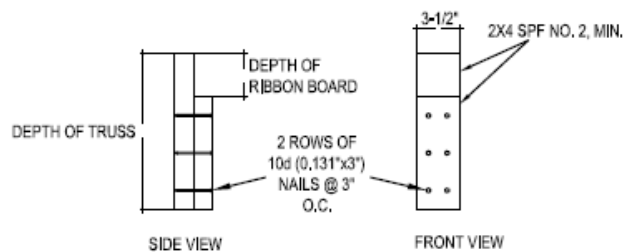

ATTACH TOP OF KEY-BLOCK TO INSIDE FACE OF RIBBON BOARD WITH 2 - 10d (0,131\" x 3\") THROUGH NAILS AND 2 - 10d TOE-NAILS. ATTACH BOTTOM OF KEY-BLOCK TO SILL PLATE WITH 4 - 10d TOE-NAILS

**Detail 1: Attachment of Deck Ledger to Floor System with MPCW Trusses**

Joist Span	≤ to 6'	6'-1\" to 8'	8'-1\" to 10'	10'-1\" to 12'	12'-1\" to 14'	14'-1\" to 16'	16'-1\" to 18'
Connection Details	On-center Spacing of Fasteners (in.) <sup>4</sup>						
1/2\" x 6\" lag screw with 15/32\", max., wood structural panel sheathing	24	12 <sup>5</sup>	12 <sup>5</sup>	12 <sup>5</sup>	12 <sup>5</sup>	8 <sup>6</sup>	8 <sup>6</sup>
1/2\" diameter bolt with 15/32\", max., wood structural panel sheathing	24	24	24	24	24	12 <sup>5</sup>	12 <sup>5</sup>

5. Ledgers shall be flashed in accordance with applicable building code requirements to prevent water from contacting the exposed wood structural sheathing and floor truss.
6. Snow load shall not be assumed to act concurrently with live load.
7. Ledgers must be 2x10 or 2x12 PPT or code-approved decay-resistant lumber with specific gravity,  $G \geq 0.43$ . Truss 2-ply 2x4 end verticals and key-blocks must have a  $G \geq 0.42$ .
8. Stagger lag screws and bolts as shown in Detail 1.
9. Requires key-blocks at 24\" o.c., maximum. Attach ledger to 2-ply end vertical of each truss with one (1) fastener and to each key-block with one (1) fastener. Refer to Detail 1 for key-block construction and installation information.
10. Requires two (2) key-blocks at 8\" o.c., maximum, between each truss. Attach ledger to 2-ply end vertical of each truss with one (1) fastener and to each key-block with one (1) fastener. Refer to Detail 1 for key-block construction and installation information.

**Table 1:** Deck Ledger Connection to Ends of MPCW Floor Trusses Spaced 24" o.c., Max.<sup>1,2,3</sup>  
(Deck Live Load = 40 psf, Deck Dead Load = 10 psf, Snow Load  $\leq$  40 psf)

Joist Span	$\leq$ to 6'	6'-1" to 8'	8'-1" to 10'	10'-1" to 12'	12'-1" to 14'	14'-1" to 16'	16'-1" to 18'
Connection Details	On-center Spacing of Fasteners (in.) <sup>4</sup>						
1/2" x 6" lag screw with <sup>15</sup> / <sub>32</sub> " max., wood structural sheathing	12 <sup>5</sup>	12 <sup>5</sup>	12 <sup>5</sup>	8 <sup>6</sup>	8 <sup>6</sup>	8 <sup>6</sup>	Use bolted connection
1/2" diameter bolt with <sup>15</sup> / <sub>32</sub> " max., wood structural sheathing	24	24	24	12 <sup>5</sup>	12 <sup>5</sup>	12 <sup>5</sup>	12 <sup>5</sup>
<p>1. Ledgers shall be flashed in accordance with applicable building code requirements to prevent water from contacting the exposed wood structural sheathing and floor truss.</p> <p>2. Snow load shall not be assumed to act concurrently with live load.</p> <p>3. Ledgers must be 2x10 or 2x12 PPT or code-approved decay-resistant lumber with specific gravity, <math>G \geq 0.43</math>. Truss 2-ply 2x4 end verticals and key-blocks must have a <math>G \geq 0.42</math>.</p> <p>4. Stagger lag screws and bolts as shown in Detail 1.</p> <p>5. Requires key-blocks at 24" o.c., maximum. Attach ledger to 2-ply end vertical of each truss with one (1) fastener and to each key-block with one (1) fastener. Refer to Detail 1 for key-block construction and installation information.</p> <p>6. Requires two (2) key-blocks at 8" o.c., maximum, between each truss. Attach ledger to 2-ply end vertical of each truss with one (1) fastener and to each key-block with one (1) fastener. Refer to Detail 1 for key-block construction and installation information.</p>							

**Table 2:** Deck Ledger Connection to Ends of MPCW Floor Trusses Spaced 24" o.c., Max.<sup>1,2,3</sup>  
(Deck Live Load = 60 psf, Deck Dead Load = 10 psf, Snow Load  $\leq$  60 psf)

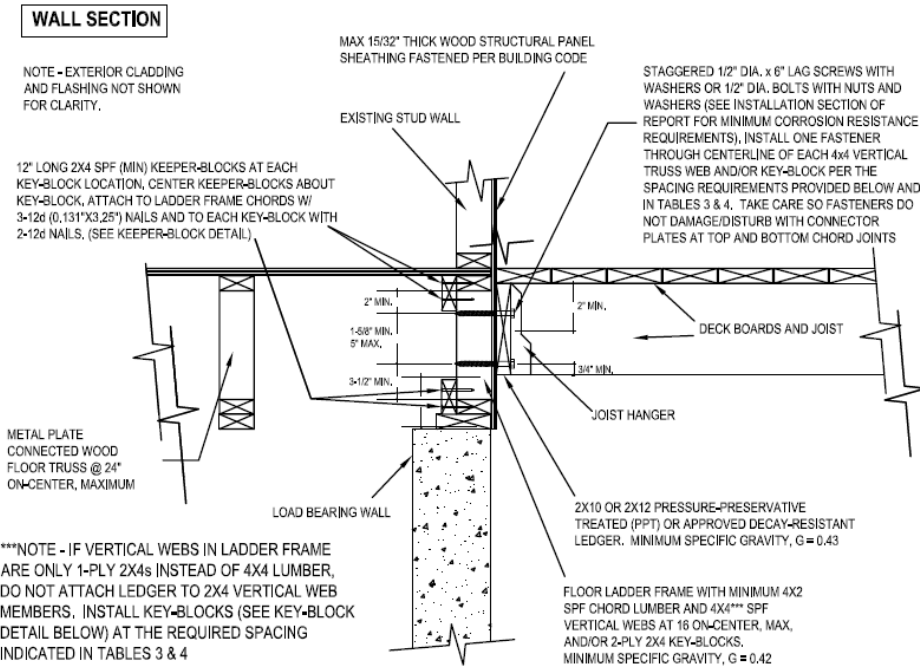

**PLACEMENT OF LAG SCREWS AND BOLTS IN LEDGER**

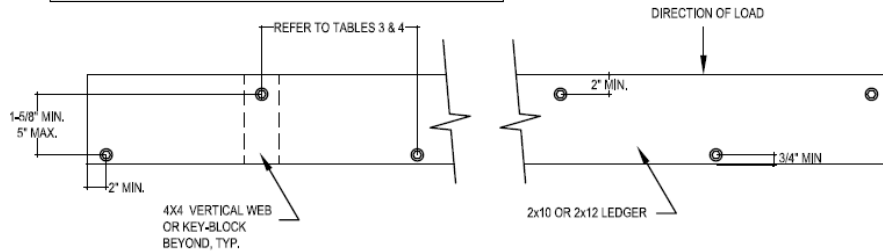

**KEY-BLOCK DETAIL FOR LEDGER ATTACHED TO SIDE OF FLOOR LADDER FRAME**

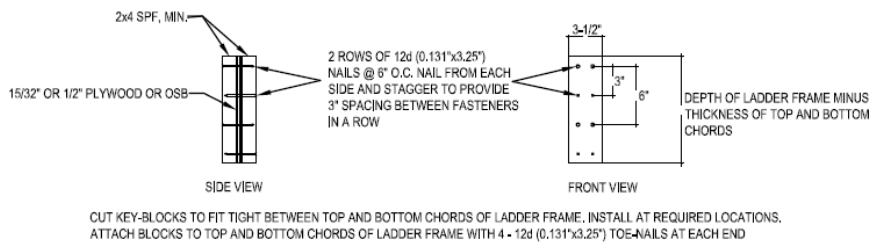

**KEEPER-BLOCK DETAIL FOR LEDGER ATTACHED TO SIDE OF FLOOR LADDER FRAME**

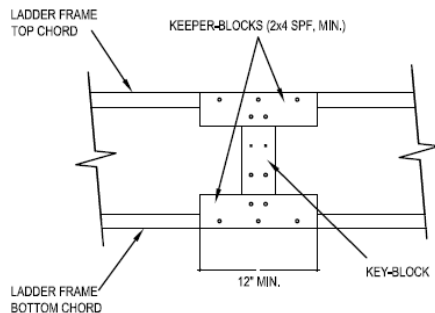

**Detail 2: Attachment of Deck Ledger to Floor System with MPCW Trusses,**  
When Ledger is Installed Parallel to Truss Span & Spacing of Screws is Less Than the Spacing of the Verticals

Joist Span	< 6' to 8'	8'-1" to 10'	10'-1" to 12'	12'-1" to 14'	14'-1" to 16'	16'-1" to 18'
Connection Details	On-center Spacing of Fasteners (in.) <sup>4</sup>					
1/2" x 6" lag screw with 15/32", max., wood structural sheathing	16	16	8 <sup>b</sup>	8 <sup>b</sup>	8 <sup>b</sup>	8 <sup>b</sup>
1/2" diameter bolt with 15/32", max., wood structural sheathing	32	32	16	16	16	16
1. Ledgers shall be flashed in accordance with applicable building code requirements to prevent water from contacting the exposed wood structural sheathing and floor truss. 2. Snow load shall not be assumed to act concurrently with live load. 3. Ledgers must be 2x10 or 2x12 PPT or code-approved decay-resistant lumber with specific gravity, G > 0.43. Truss 4x4 vertical web and key-blocks must have a G > 0.42. 4. Stagger lag screws and bolts as shown in Detail 2. 5. Requires key-blocks at 16" o.c., maximum. Attach ledger to each 4x4 vertical web with one (1) fastener and to each key-block with one (1) fastener. Refer to Detail 2 for key-block construction and installation information.						

**Table 3: Deck Ledger Connection to Side of MPCW Floor Ladder Frame with 4s4 Vertical Webs Spaced at 16" o.c., Max.<sup>1,2,3</sup>**  
(Deck Live Load = 40 psf, Deck Dead Load = 10 psf, Snow Load ≤ 40 psf)

Joist Span	< 6' to 8'	8'-1" to 10'	10'-1" to 12'	12'-1" to 14'	14'-1" to 16'	16'-1" to 18'
Connection Details	On-center Spacing of Fasteners (in.) <sup>4</sup>					
1/2" x 6" lag screw with 15/32", max., wood structural sheathing	16	8 <sup>b</sup>	8 <sup>b</sup>	8 <sup>b</sup>	8 <sup>b</sup>	Use bolted connection
1/2" diameter bolt with 15/32", max., wood structural sheathing	32	16	16	16	8 <sup>b</sup>	8 <sup>b</sup>
1. Ledgers shall be flashed in accordance with applicable building code requirements to prevent water from contacting the exposed wood structural sheathing and floor truss. 2. Snow load shall not be assumed to act concurrently with live load. 3. Ledgers must be 2x10 or 2x12 PPT or code-approved decay-resistant lumber with specific gravity, G > 0.43. Truss 4x4 vertical web and key-blocks must have a G > 0.42. 4. Stagger lag screws and bolts as shown in Detail 2. 5. Requires key-blocks at 16" o.c., maximum. Attach ledger to each 4x4 vertical web with one (1) fastener and to each key-block with one (1) fastener. Refer to Detail 2 for key-block construction and installation information.						

**Table 4: Deck Ledger Connection to Side of MPCW Floor Ladder Frame with 4x4 Vertical Webs Spaced at 16" o.c., Max.<sup>1,2,3</sup>**  
(Deck Live Load = 60 psf, Deck Dead Load = 10 psf, Snow Load ≤ 60 psf)

**LEDGER ATTACHED TO ENDS OF TRUSSES**

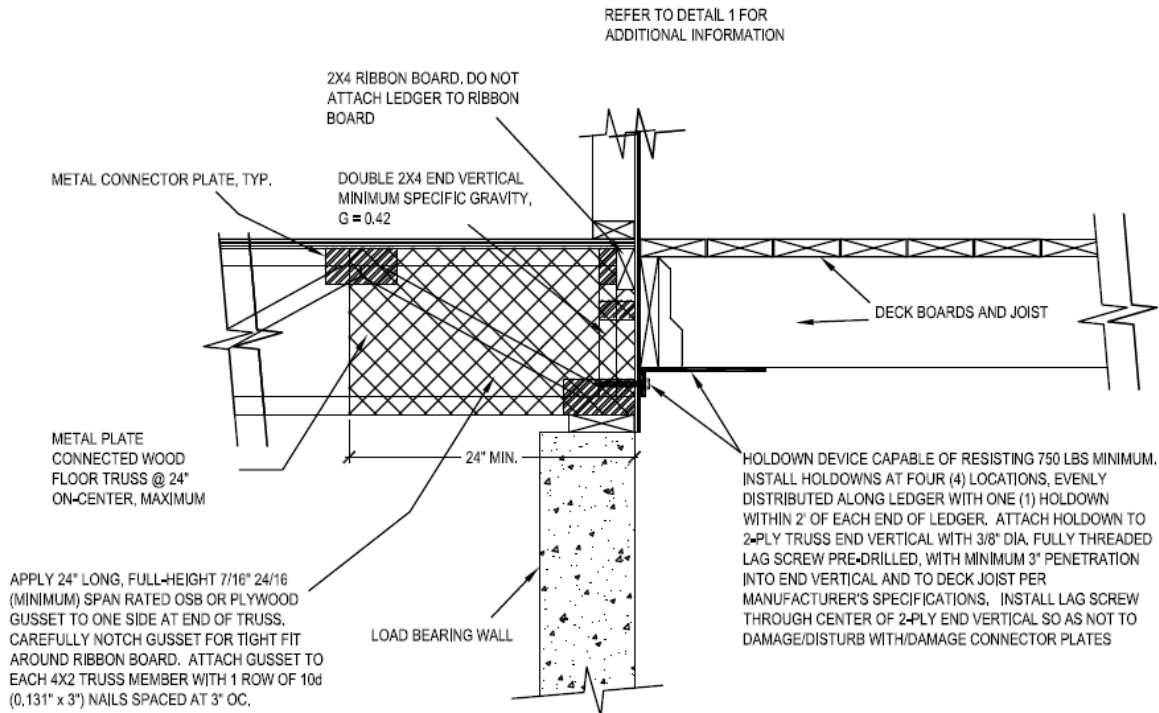

**LEDGER ATTACHED TO SIDE OF FLOOR LADDER FRAME**

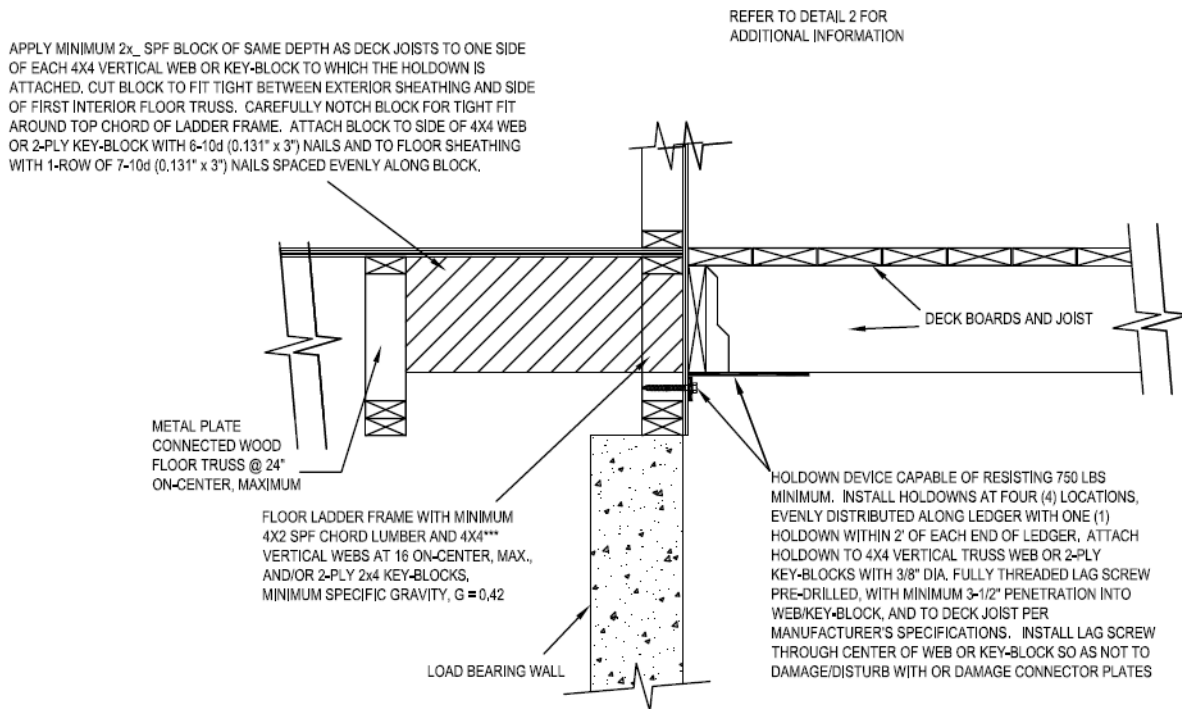

**Detail 3: Deck Lateral Load Connection Capable of Resisting the 1500 lbf Lateral Load Requirement**

Specified in 2009 & 2012 IRC Section 507



**Findings:**

Nailing deck ledgers to metal plate connected wood truss floor systems is not sufficient. The deck ledger must be attached to the truss or key-block with lag screws or bolts. Various options and connection details for achieving the connection of the deck ledger to the metal plate connected wood truss floor system are provided in this report, which may be referred to by the building designer to achieve a code-conforming deck ledger connection.

IBC Section 104.11 and IRC Section R104.11 (IFC Section 104.9 is similar) state:

**104.11 Alternative materials, design and methods of construction and equipment.** The provisions of this code are not intended to prevent the installation of any material or to prohibit any design or method of construction not specifically prescribed by this code, provided that any such alternative has been *approved*. An alternative material, design or method of construction shall be *approved* where the *building official* finds that the proposed design is satisfactory and complies with the intent of the provisions of this code, and that the material, method or work offered is, for the purpose intended, at least the equivalent of that prescribed in this code. . . . Where the alternative material, design or method of construction is not *approved*, the *building official* shall respond in writing, stating the reasons the alternative was not *approved*.

This research report is subject to periodic review and revision. For the most recent version of this report, visit [sbcindustry.com](http://sbcindustry.com). For information on the current status of this report, contact SBCA.

**References and Substantiating Data:**

- Anderson, C.A., Woeste, F.E. and Loferski, J.R. 2003; *Manual for the Inspection of Residential Wood Decks and Balconies*; Forest Products Society, 2801 Marshall Ct., Madison, WI 53705.
- ANSI/AWC NDS-2012, *ASD/LRFD NDS®*; *National Design Specification for Wood Construction*. 2012; American Wood Council, 222 Catoctin Circle, SE, Suite 201, Leesburg, VA 20175.
- Carradine, D.M., Bender, D., Loferski, J.R. and Woeste, F.E. 2005; Residential Deck Ledger Design; *Building Safety Journal*, December, 2005: (4-7).
- Carradine, D.M., Bender, D., Loferski, J.R. and Woeste, F.E. 2006; Residential Deck Ledger Connection Testing and Design; *Structure Magazine*, May, 2008: (53-56).
- Design for Code Acceptance, DCA 6, Prescriptive Residential Wood Deck Construction Guide; 2009; American Wood Council, 222 Catoctin Circle, SE, Suite 201, Leesburg, VA 20175.
- Loferski, J.R., Woeste, F.E., Caudill, R., Platt, T. and Smith, Q. 2004; Load-Tested Deck Ledger Connections; *Journal of Light Construction*. 22(6):71-78.
- Woeste, F.E. 2008; Safe and Durable Coastal Decks; *Coastal Contractor*, March/April, 2008: (1-7).

<sup>NO\_KEY</sup> The last sentence is adopted language in the 2015 codes.