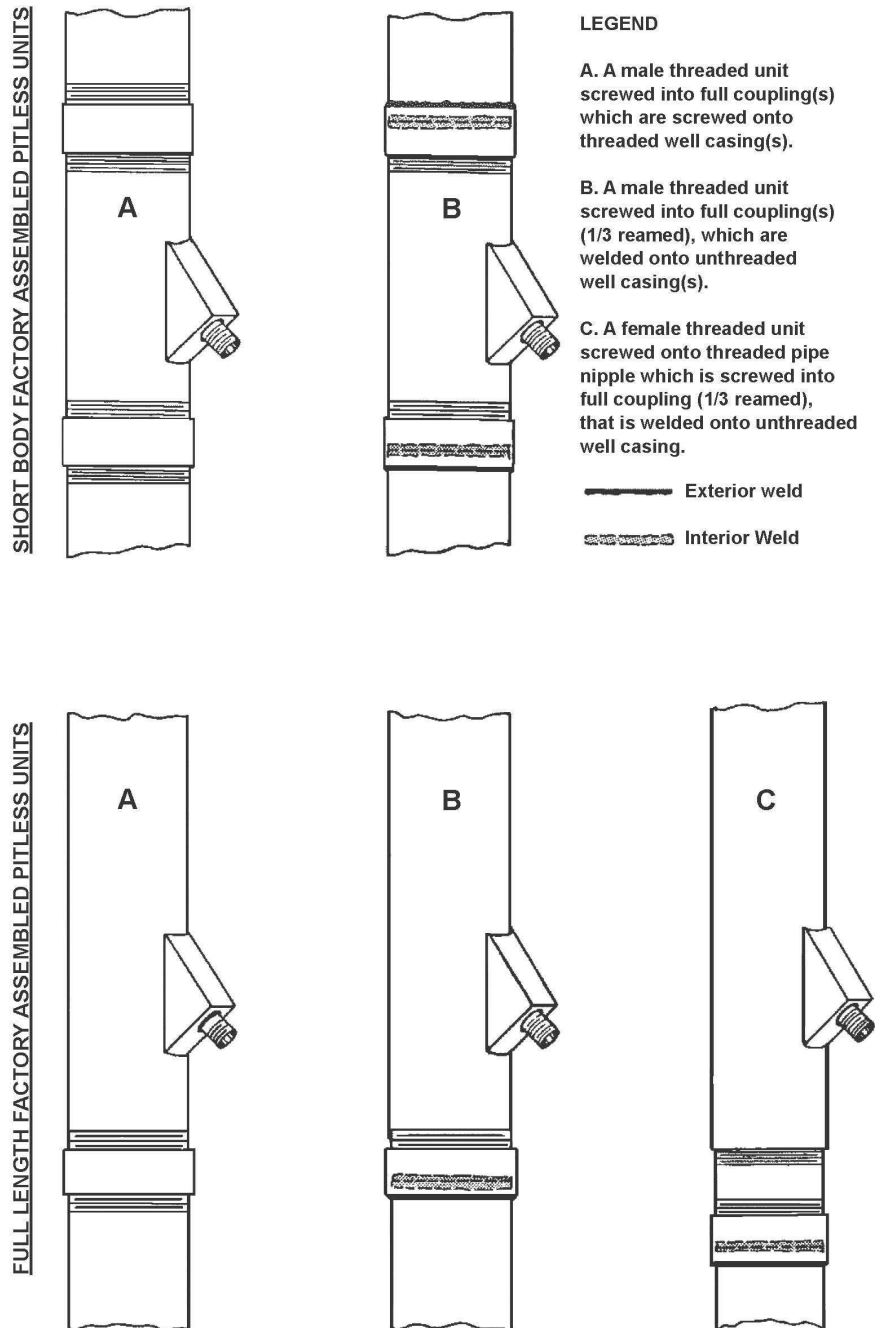


## Chapter NR 812

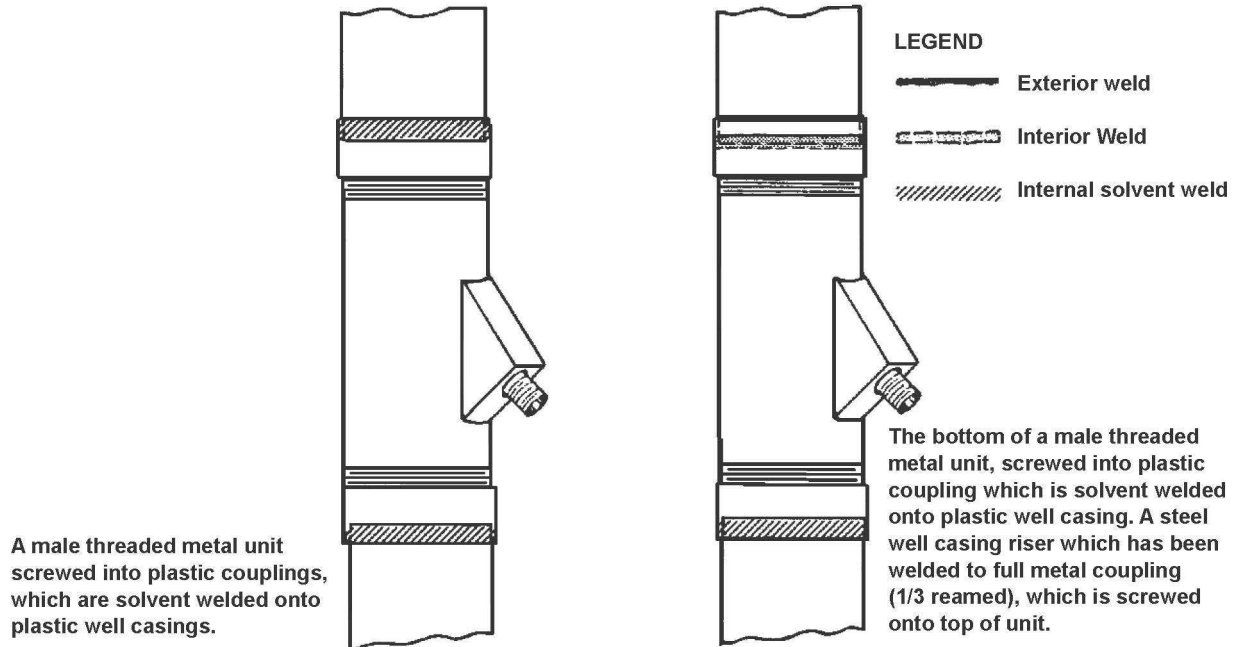
### APPENDIX

**Figure 1. Pitless unit connections for wells with steel well casing pipe.**

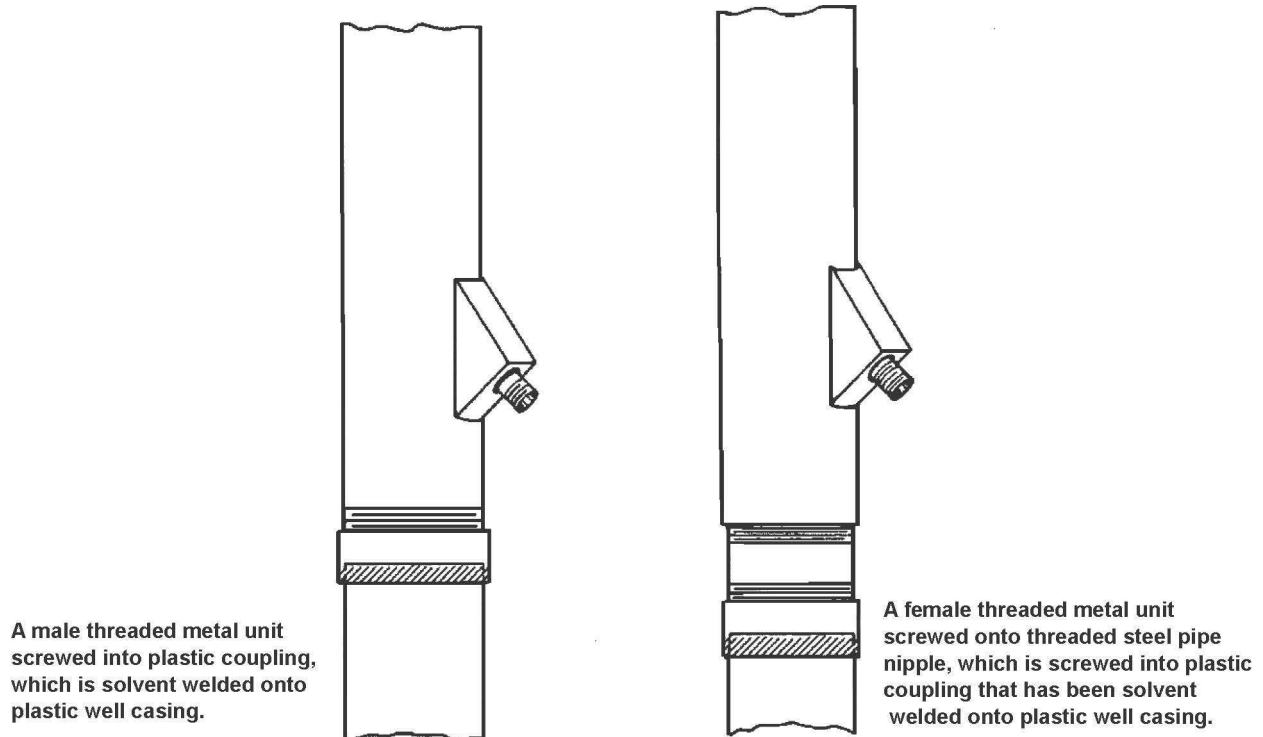


**Figure 2. Pitless unit connections for wells with thermoplastic well casing pipe.**

**SHORT BODY FACTORY ASSEMBLED PITLESS UNITS**



**FULL LENGTH FACTORY ASSEMBLED PITLESS UNITS**



**Figure 3. High capacity well pump installation depicting pumpage and water level measuring devices, well vents and air-relief vacuum breakers.**

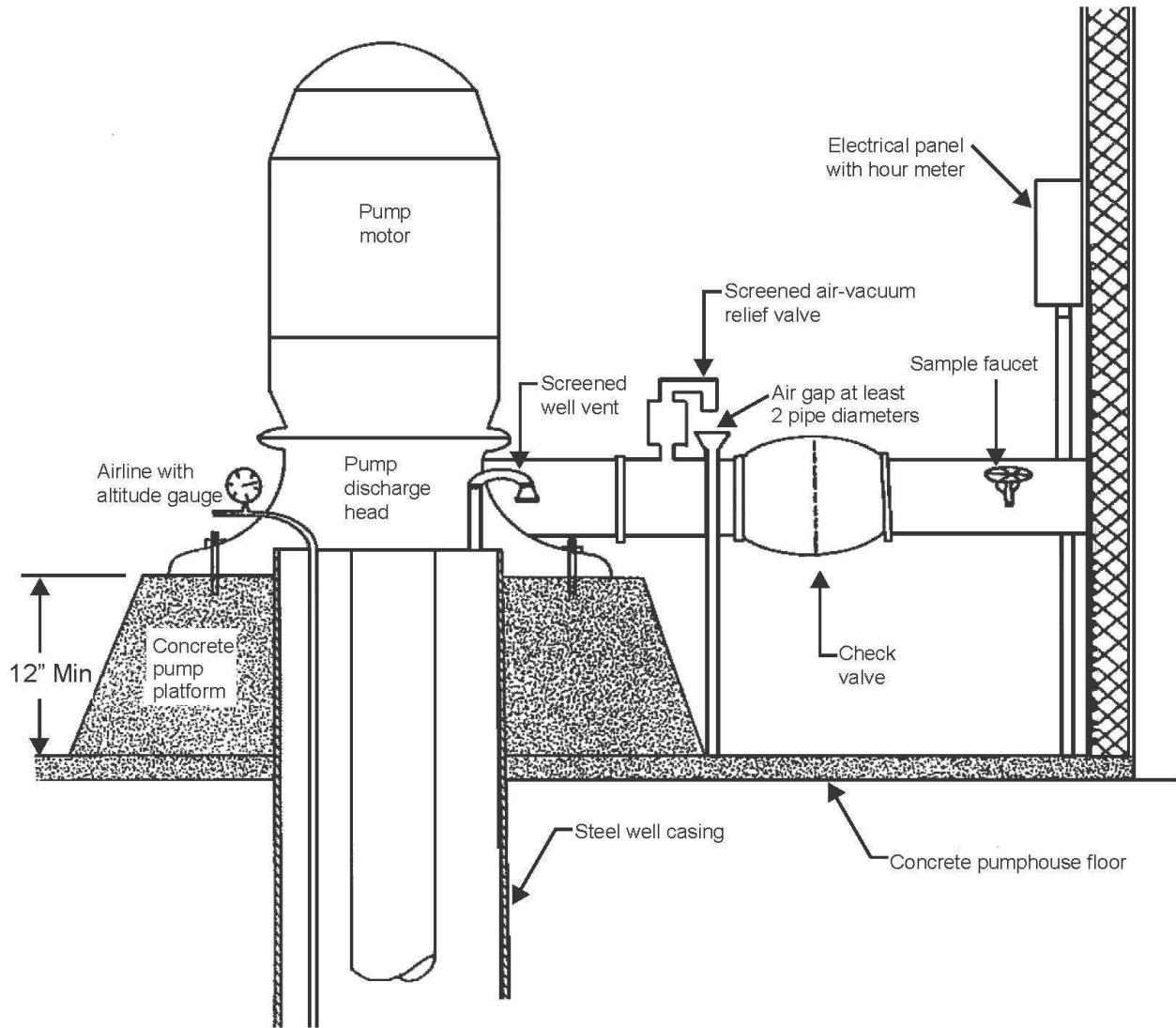
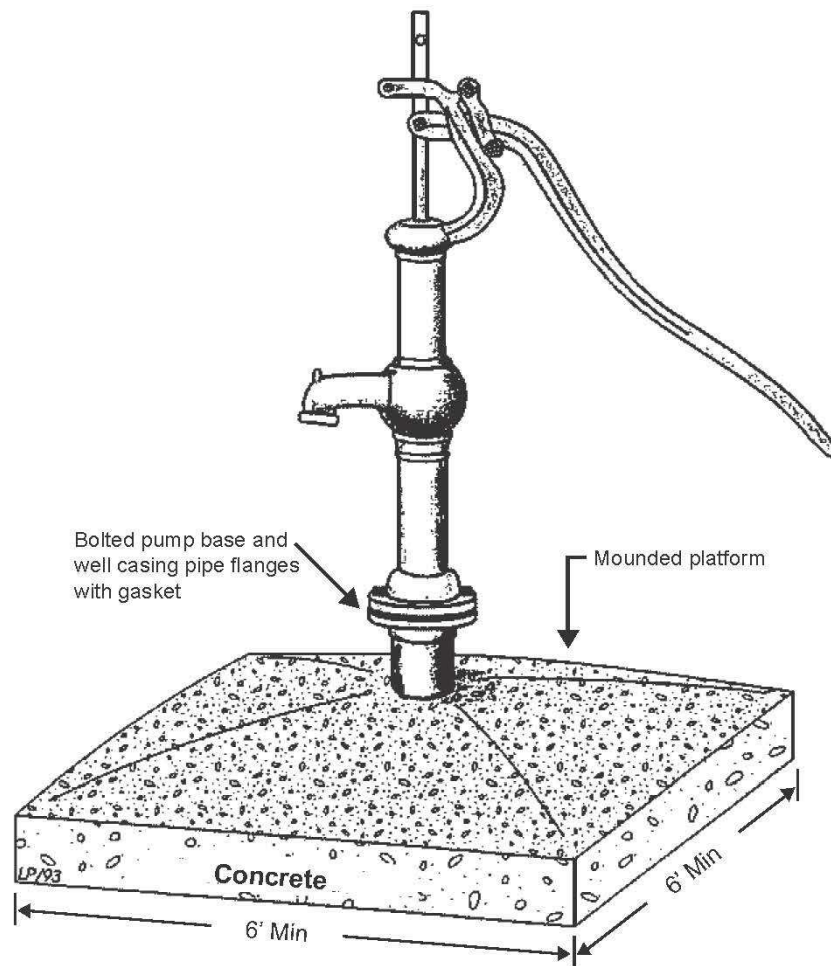


Figure 4. Hand pump



**Figure 5. Flowing well - Overflow piping arrangement with a submersible pump.**

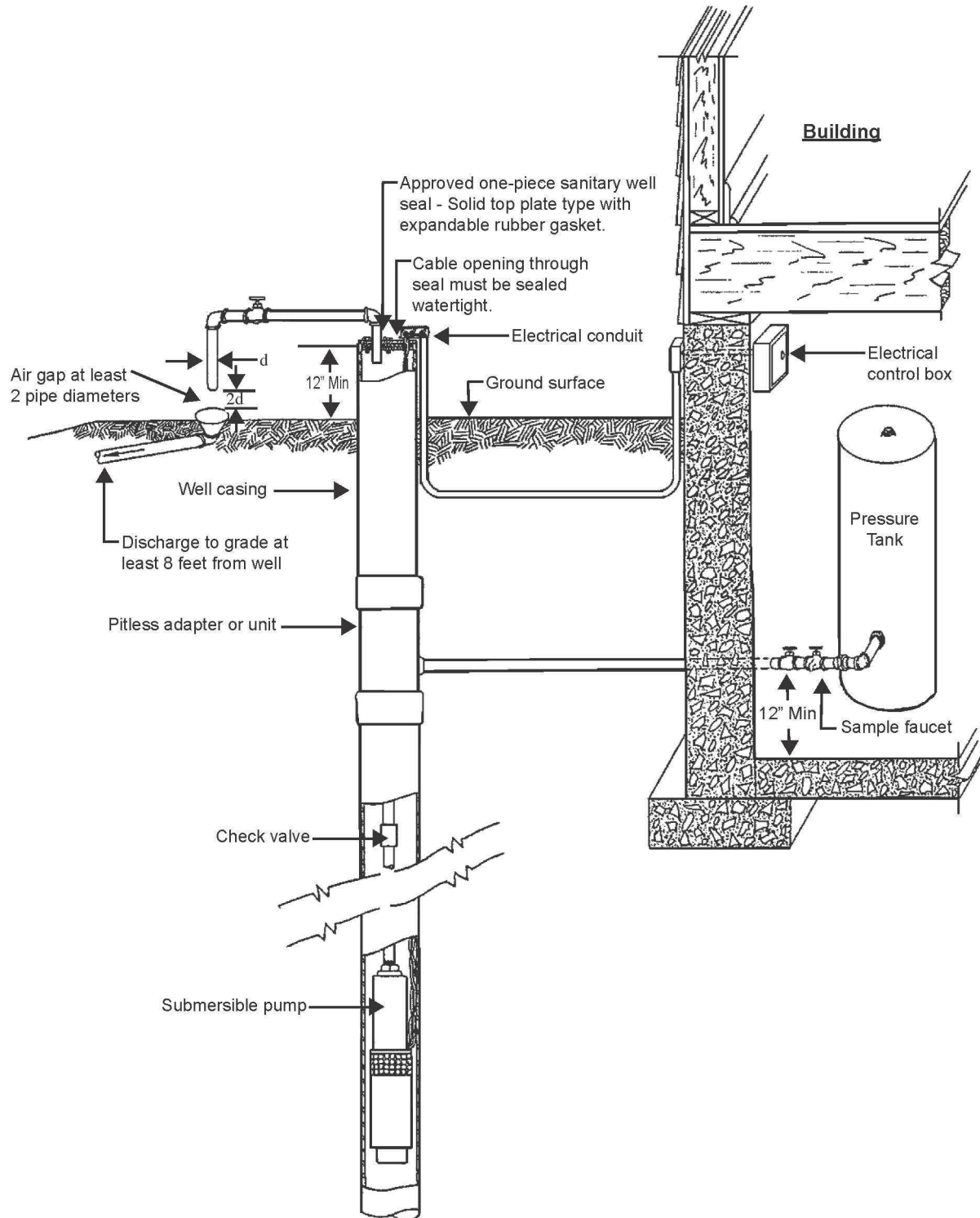
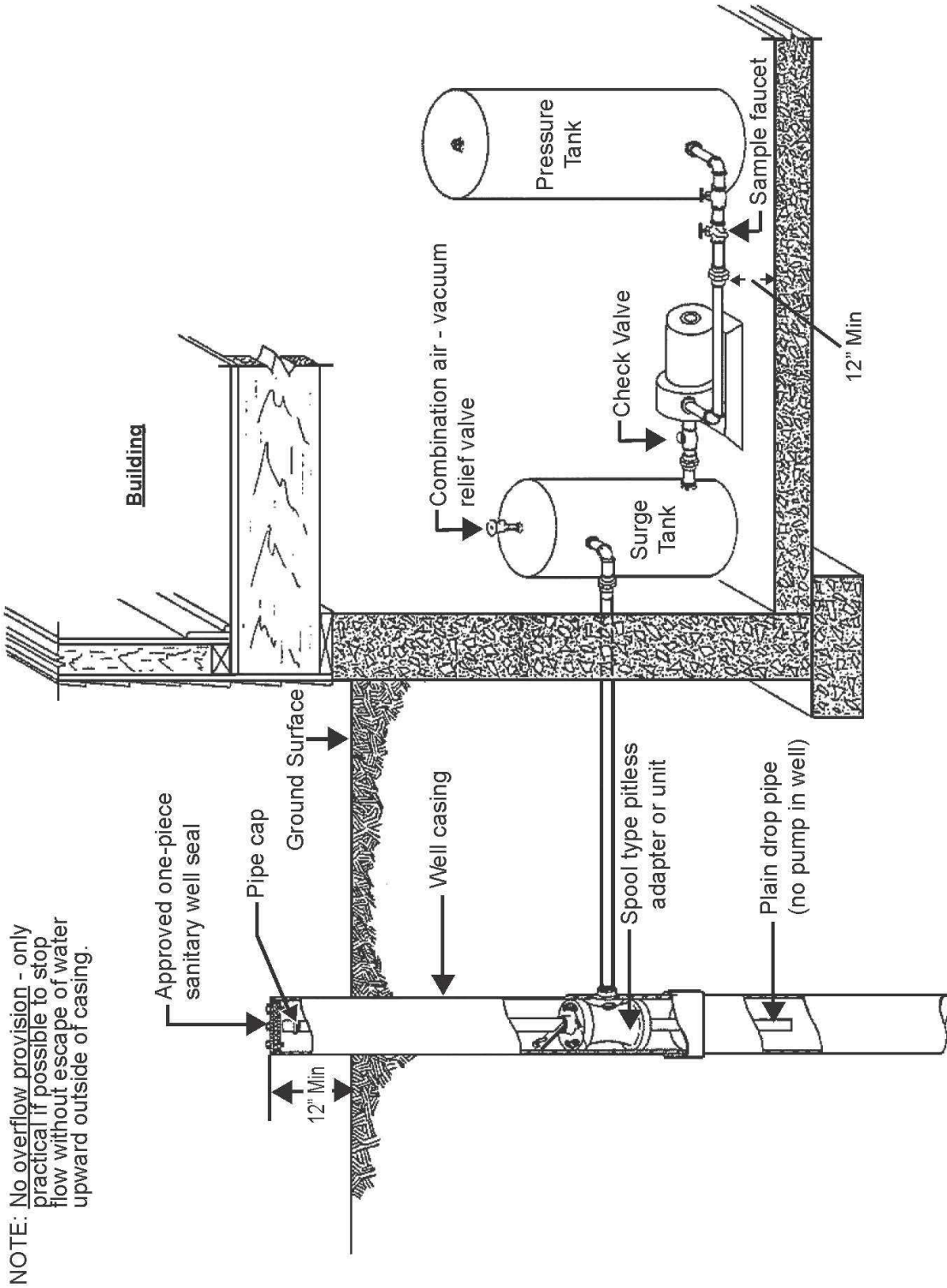


Figure 6. Flowing well - surge tank installation.



NOTE: No overflow provision - only practical if possible to stop flow without escape of water upward outside of casing.

**Figure 7. Flowing well - Overflow piping arrangement with a surge tank and no pump.**

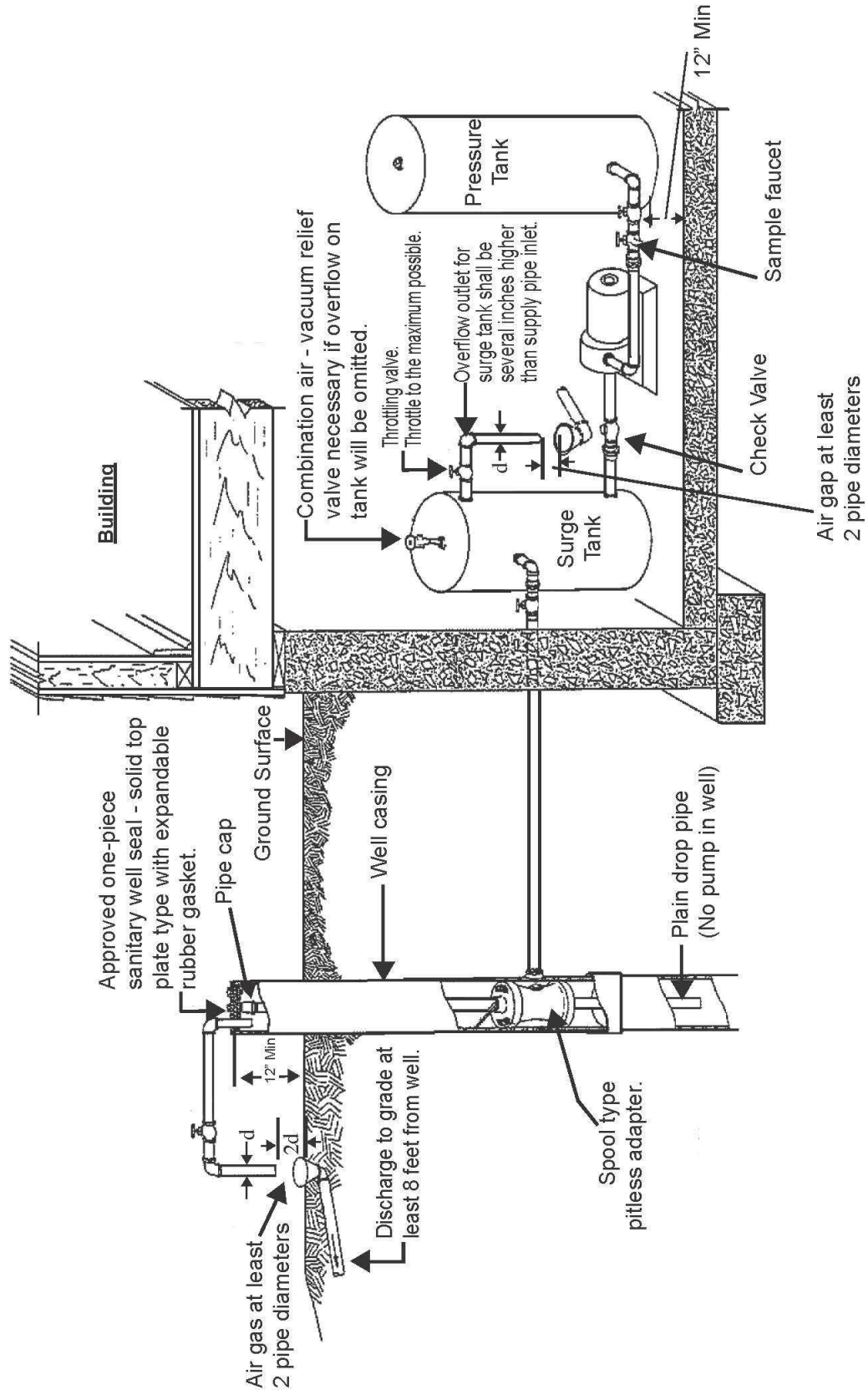


Figure 8. Reservoir specifications.

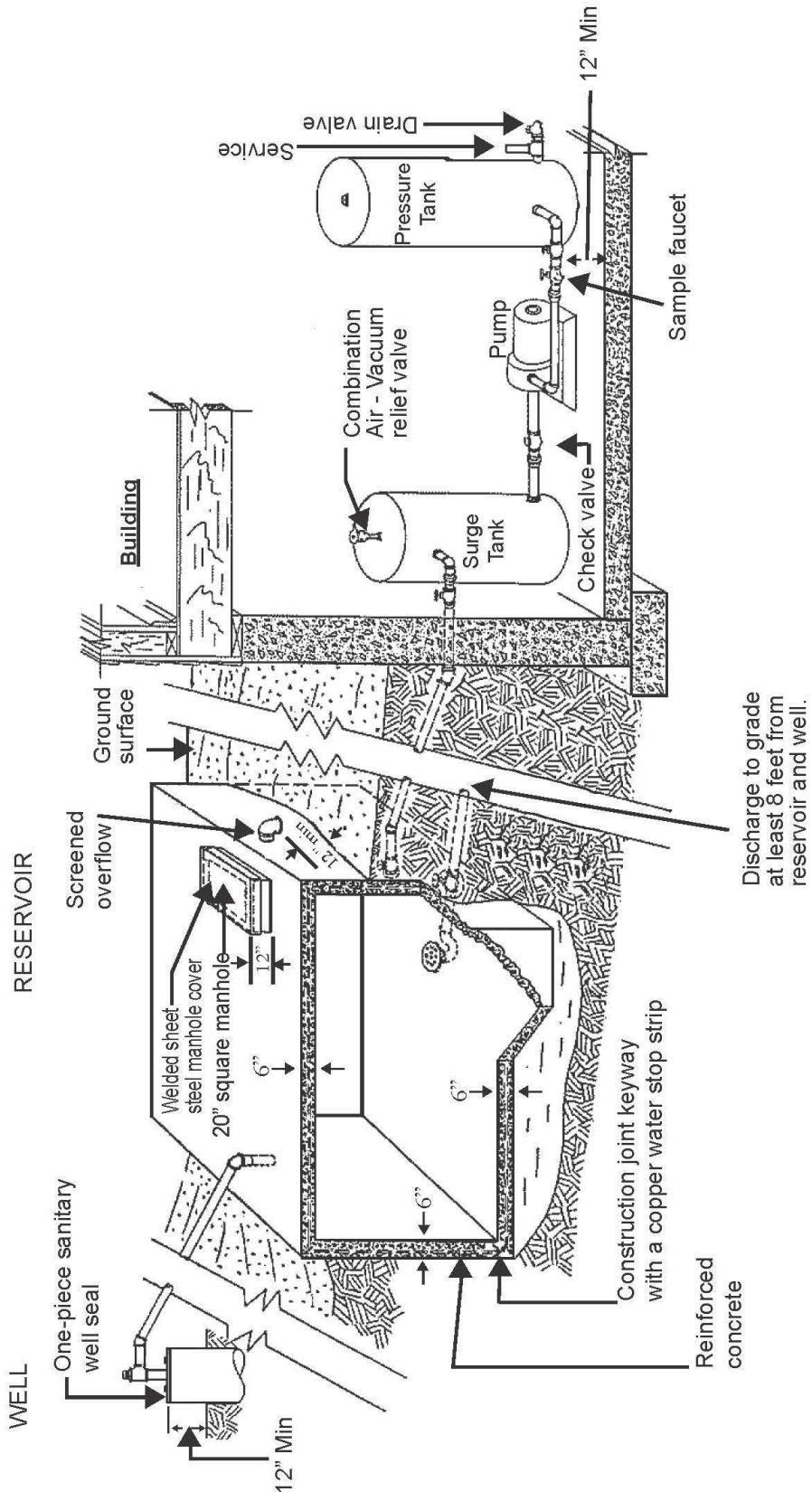




Figure 9. Well pits - Minimum requirements

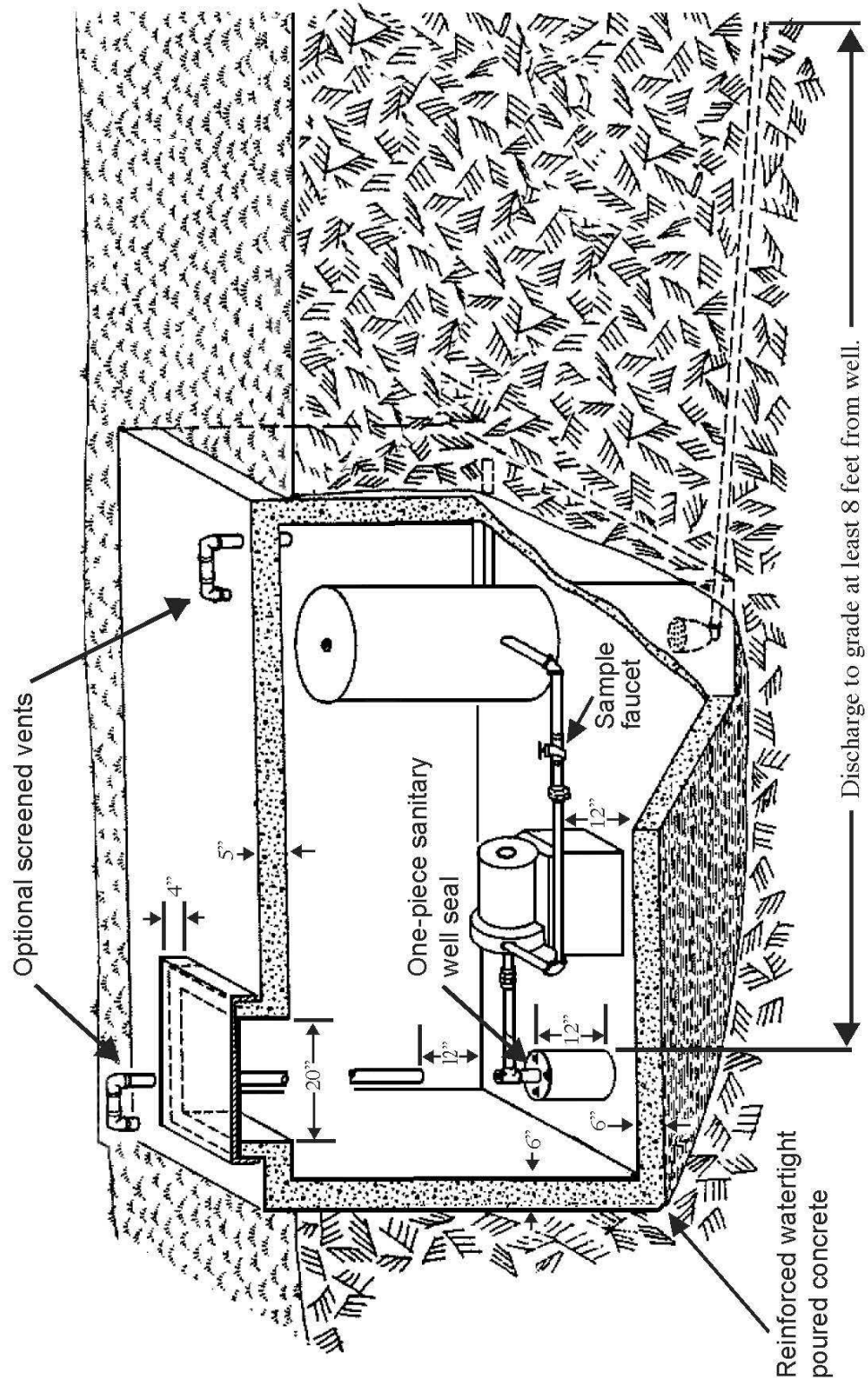
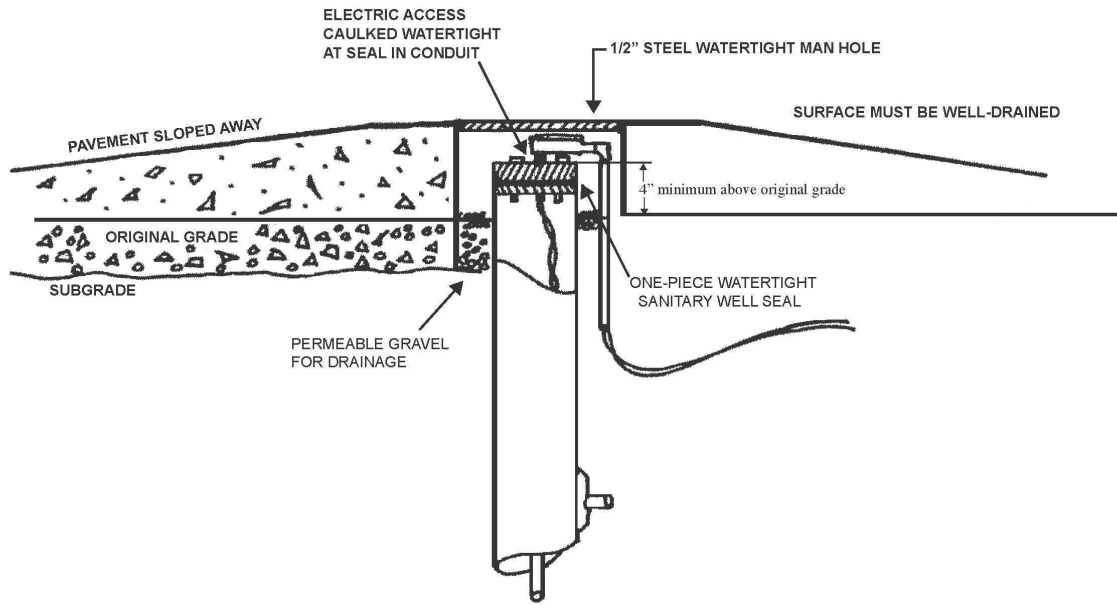


Figure 10. Driveway Ramp Installation



**Figure 11. Well pits - Minimum requirements for pits installed on or before April 10, 1953.**

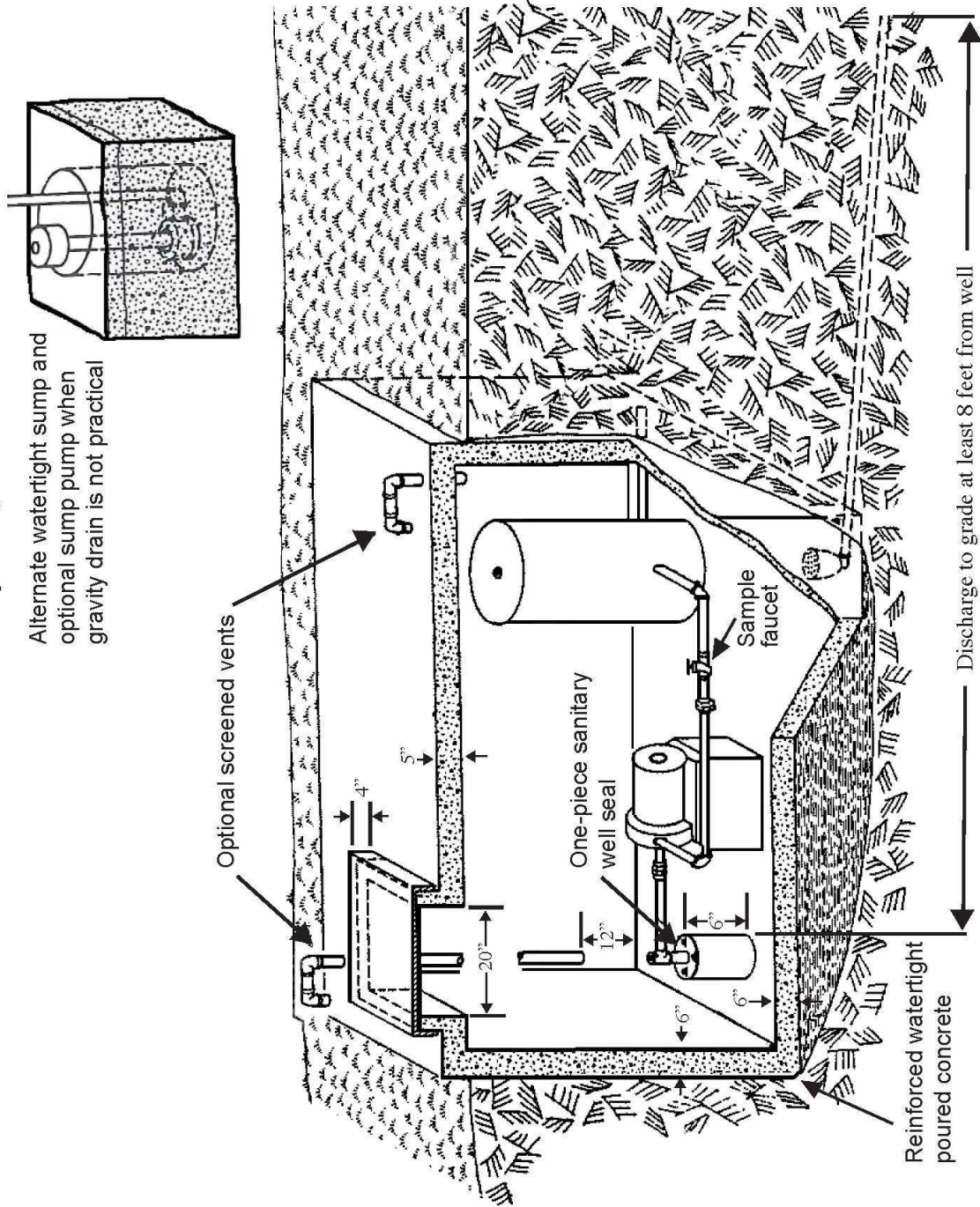
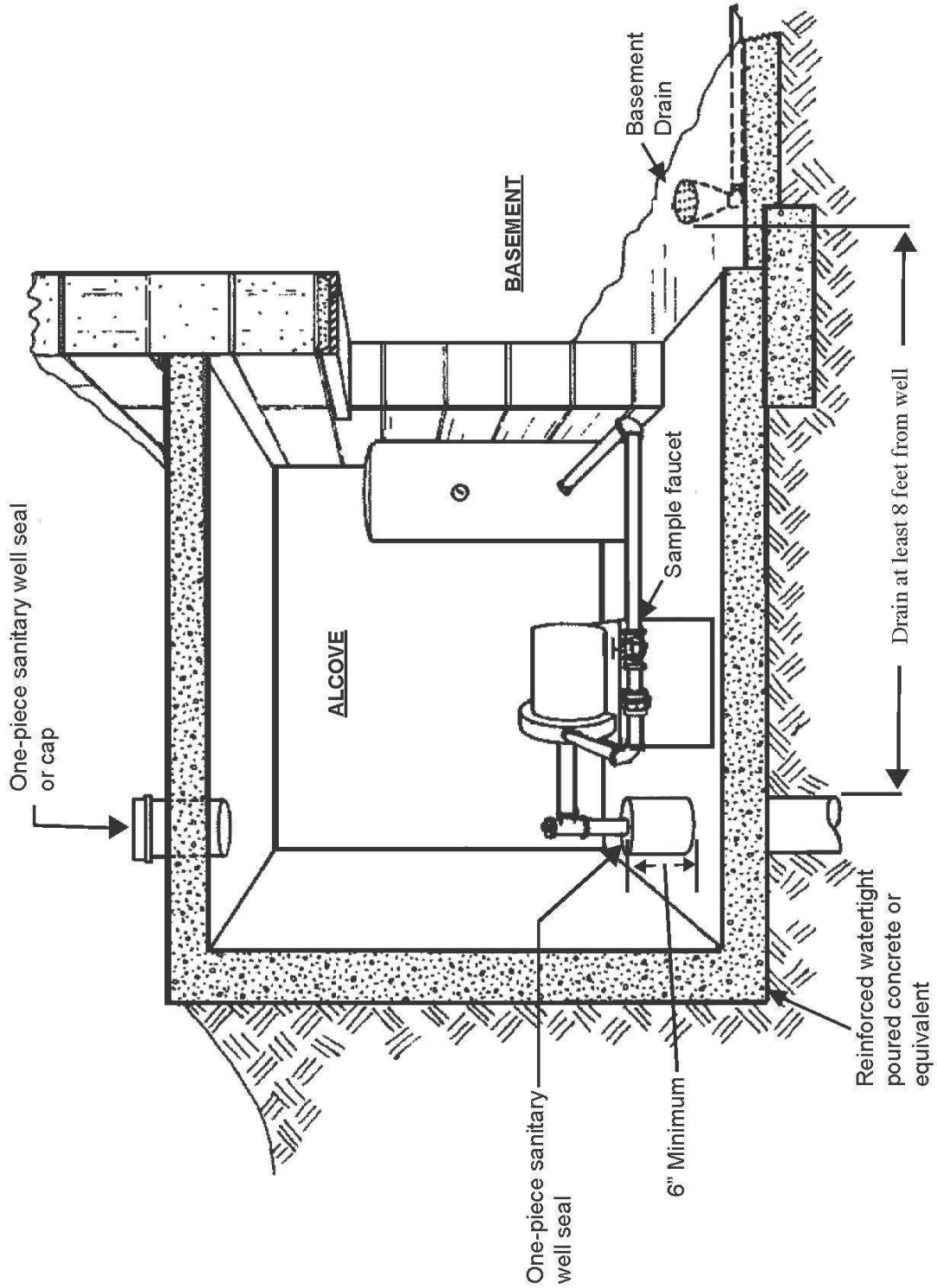
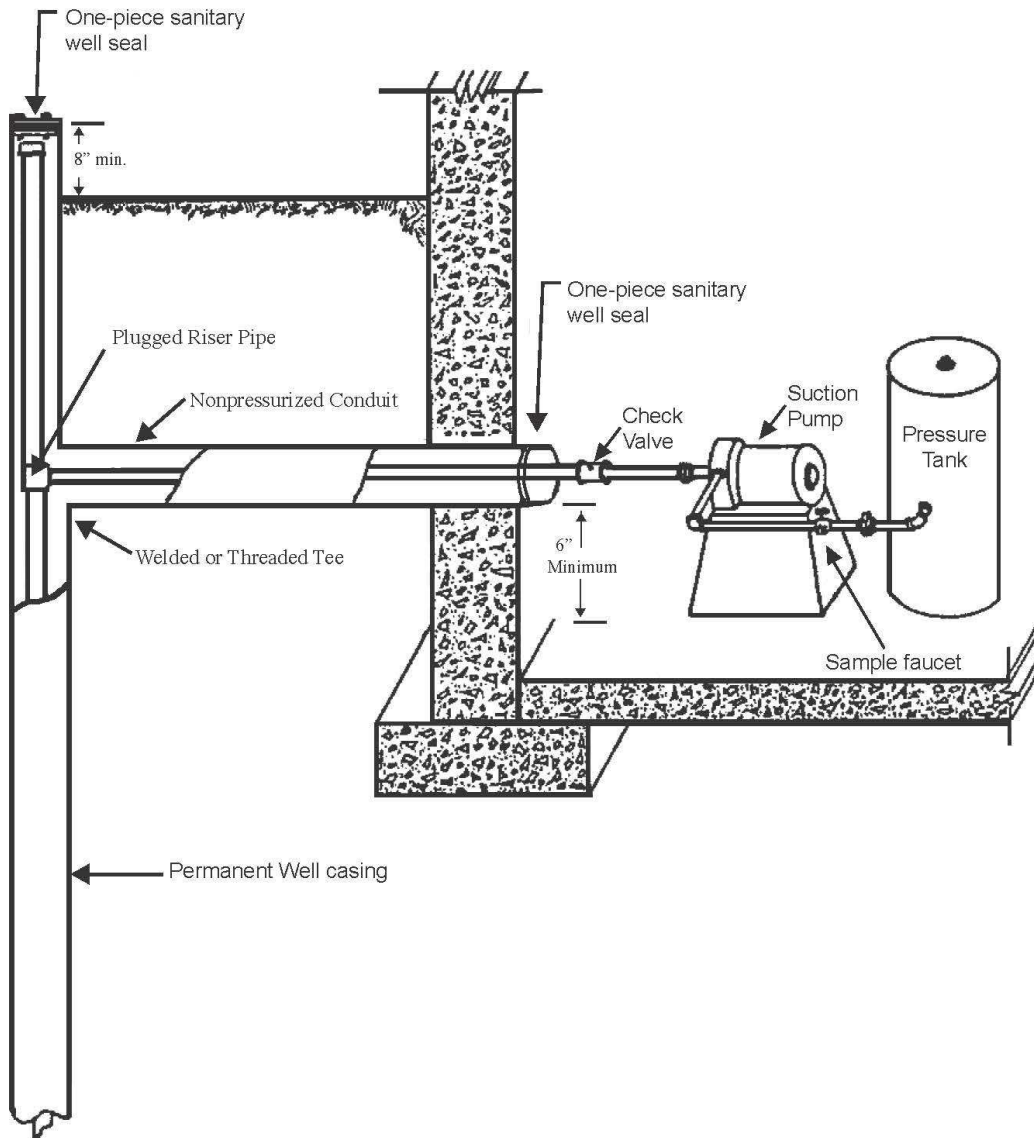


Figure 12. Alcove - Requirements for an alcove installed on or before April 10, 1953



**Figure 13. Minimum requirements for pump installations for wells with nonpressurized conduit installed prior to February 1, 1991**



**Figure 14. Pump installation for a deep well jet pump assembly and a nonpressurized conduit installed prior to February 1, 1991**

