

A-82.33 (6)-1. INDIRECT WASTE PIPING.

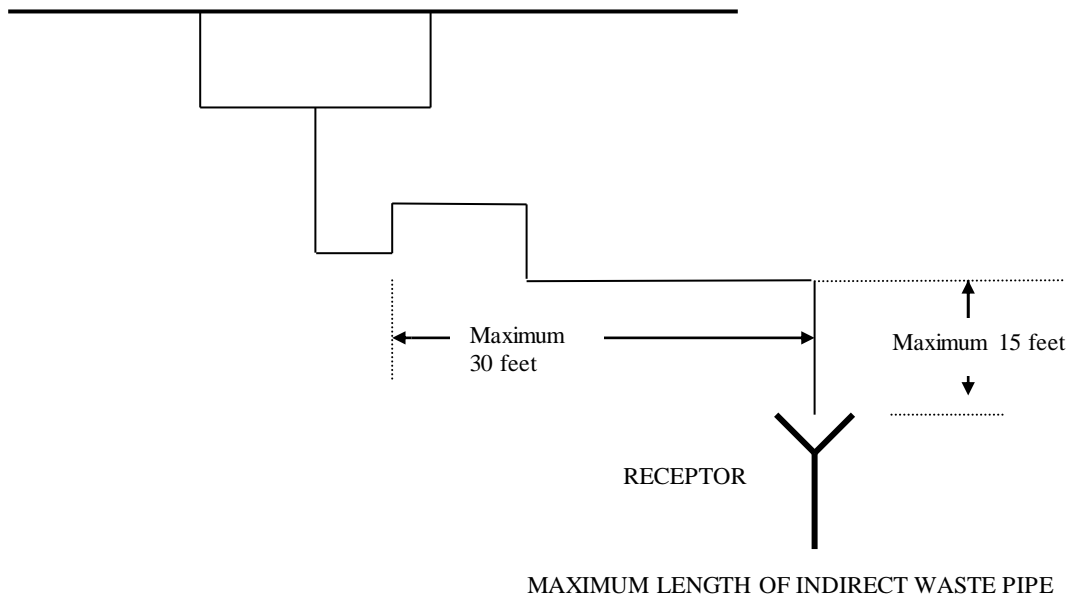

A-82.33 (6)-2. LOCAL WASTE PIPING.

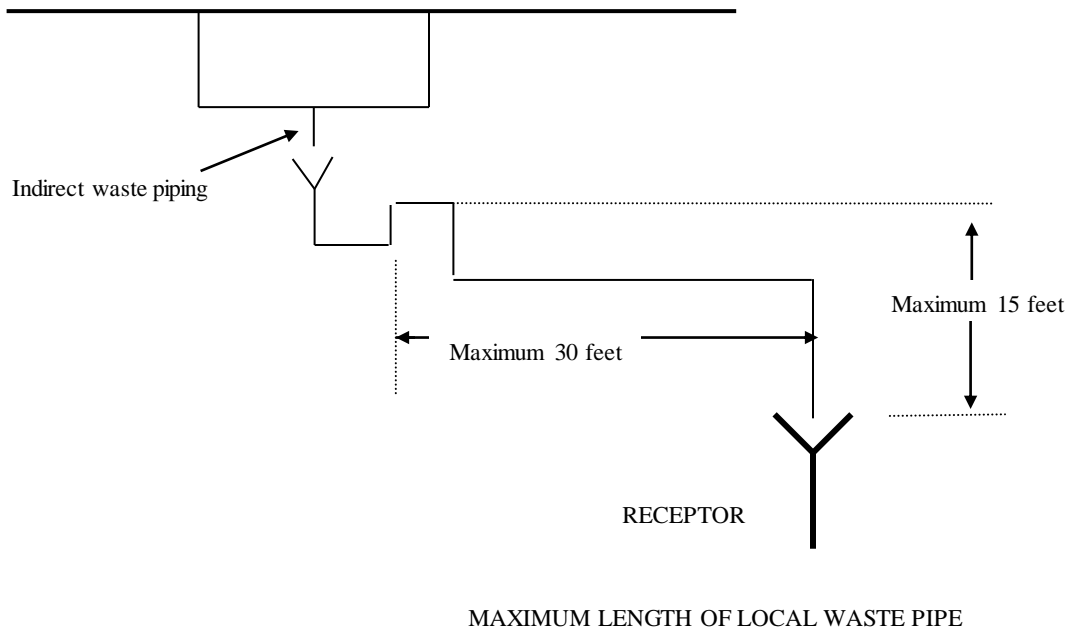

A-82.33 (7) AIR-GAPS AND AIR-BREAKS.

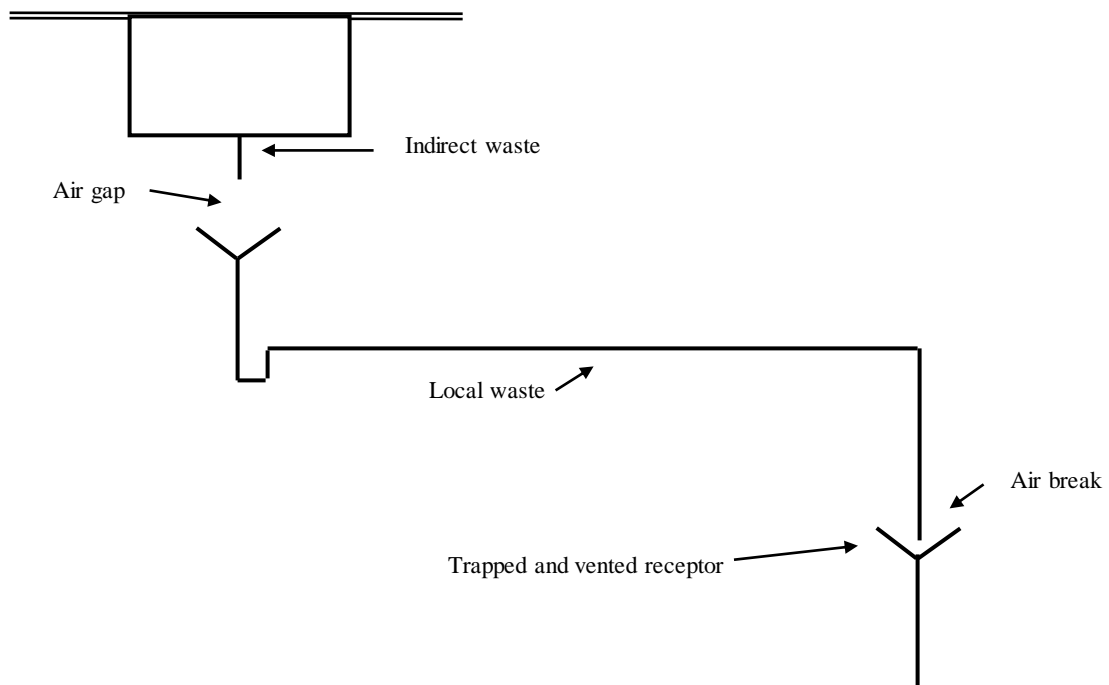
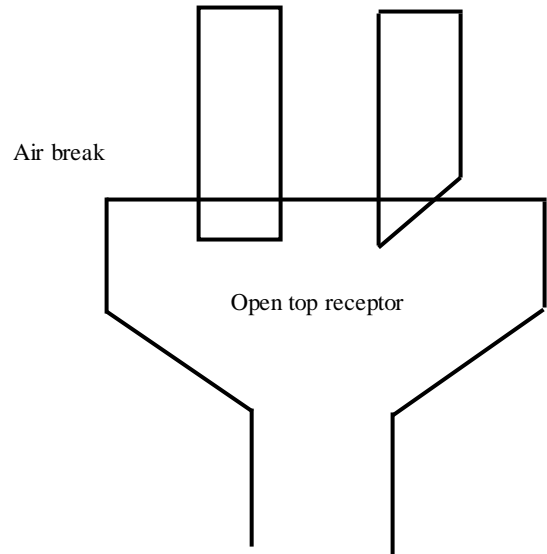
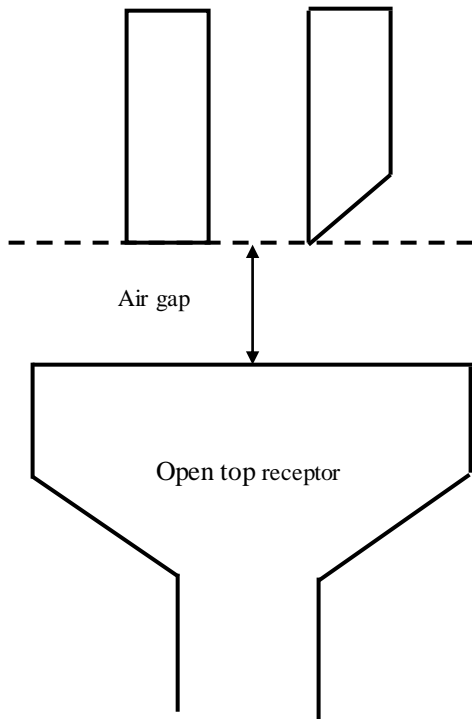

A-82.33 (8) (a) WASTE SINKS AND STANDPIPES.

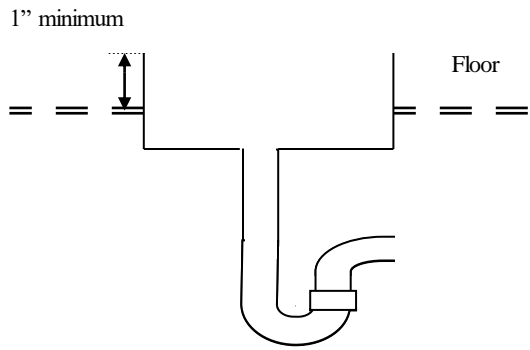

WASTE SINK IN

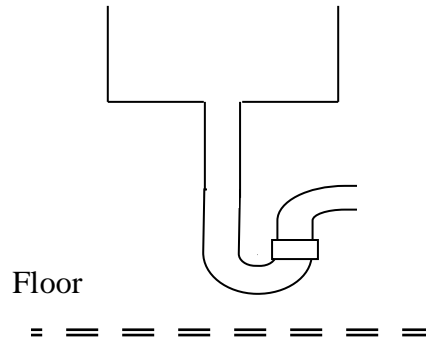

WASTE SINK ABOVE

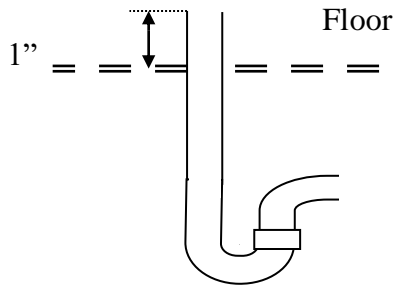

STANDPIPE IN

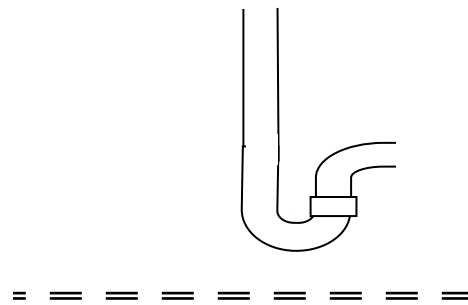

STANDPIPE ABOVE

A-82.33 (8) (b) FLOOR SINKS.

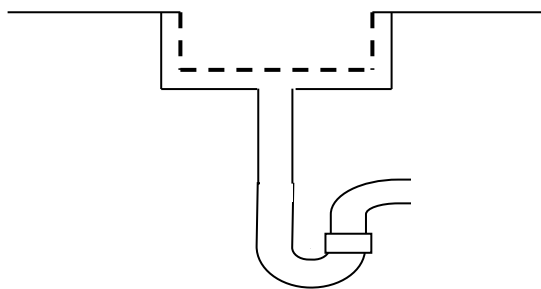

FLOOR SINK WITH

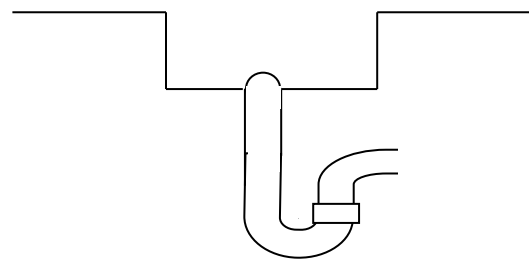

FLOOR SINK WITH DOME

A-82.33 (8) (b) FLOOR SINK WITH GRATE OPENING.

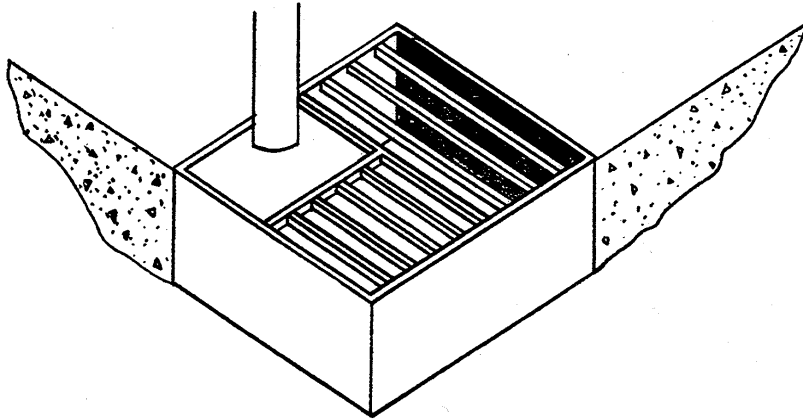

A-82.33 (8) (c)-1. LOCAL WASTE PIPING.

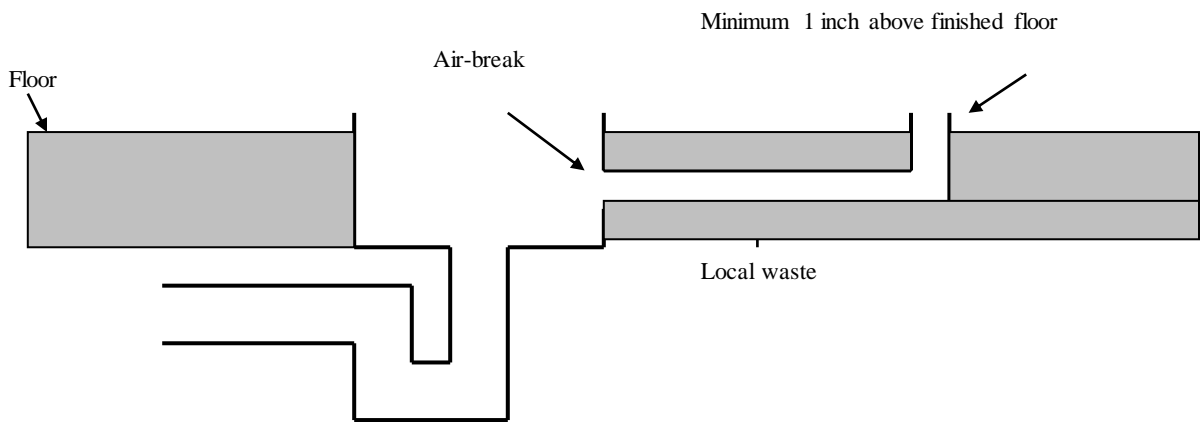

LOCAL WASTE LEADING TO A WASTE SINK, FLOOR SINK OR FLOOR DRAIN

A-82.33 (8)(c)-2. LOCAL WASTE PIPING

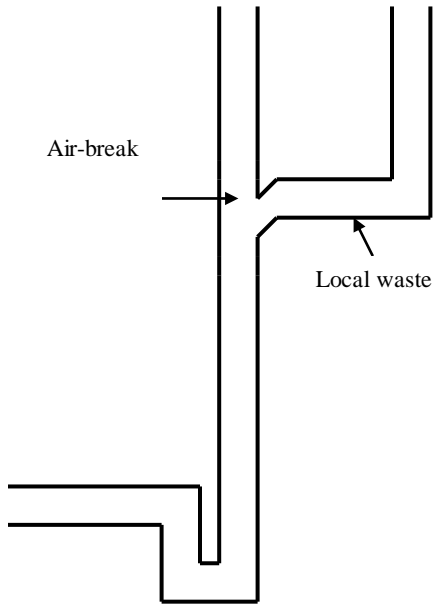

LOCAL WASTE DISCHARGING TO STANDPIPE

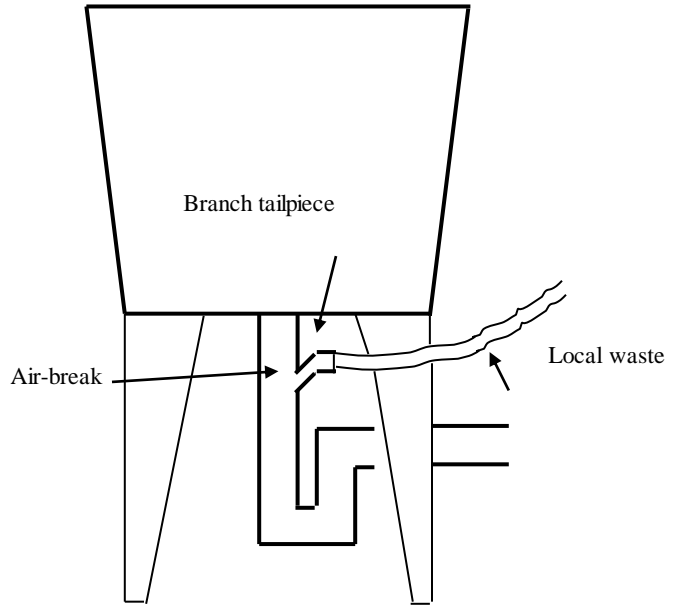

LOCAL WASTE DISCHARGING TO BRANCH TAILPIECE

A-82.33 (8)(d)-1. LOCAL WASTE PIPING SERVING WATER HEATER TEMPERATURE AND PRESSURE RELIEF VALVES.

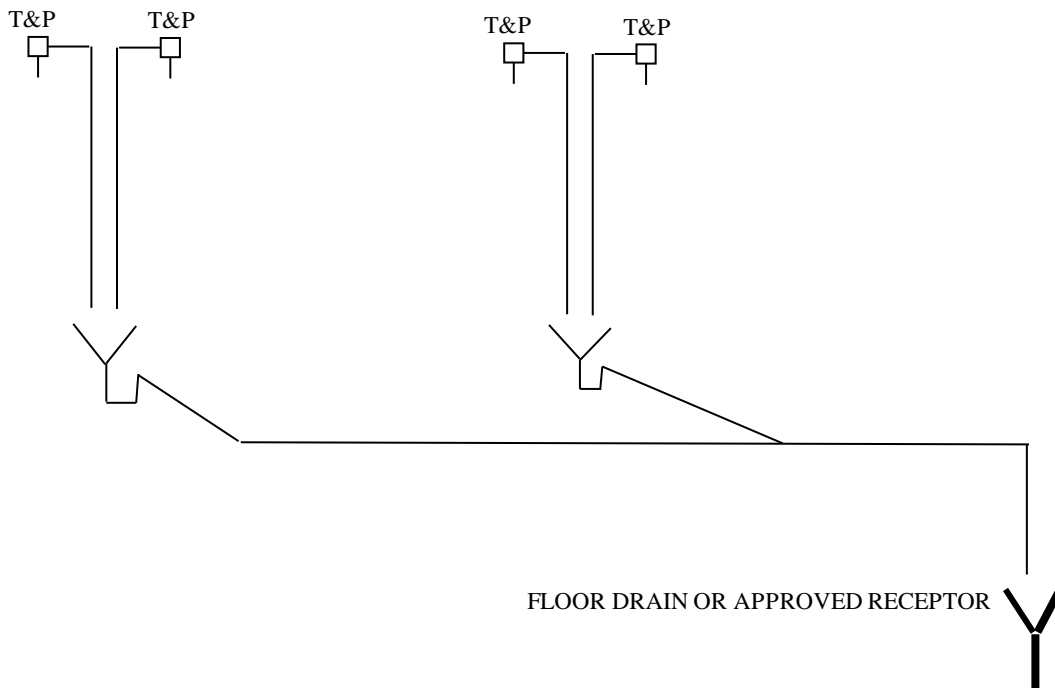

A-82.33 (8) (d)-2. LOCAL WASTE PIPING SERVING WATER HEATER TEMPERATURE AND PRESSURE RELIEF VALVES.

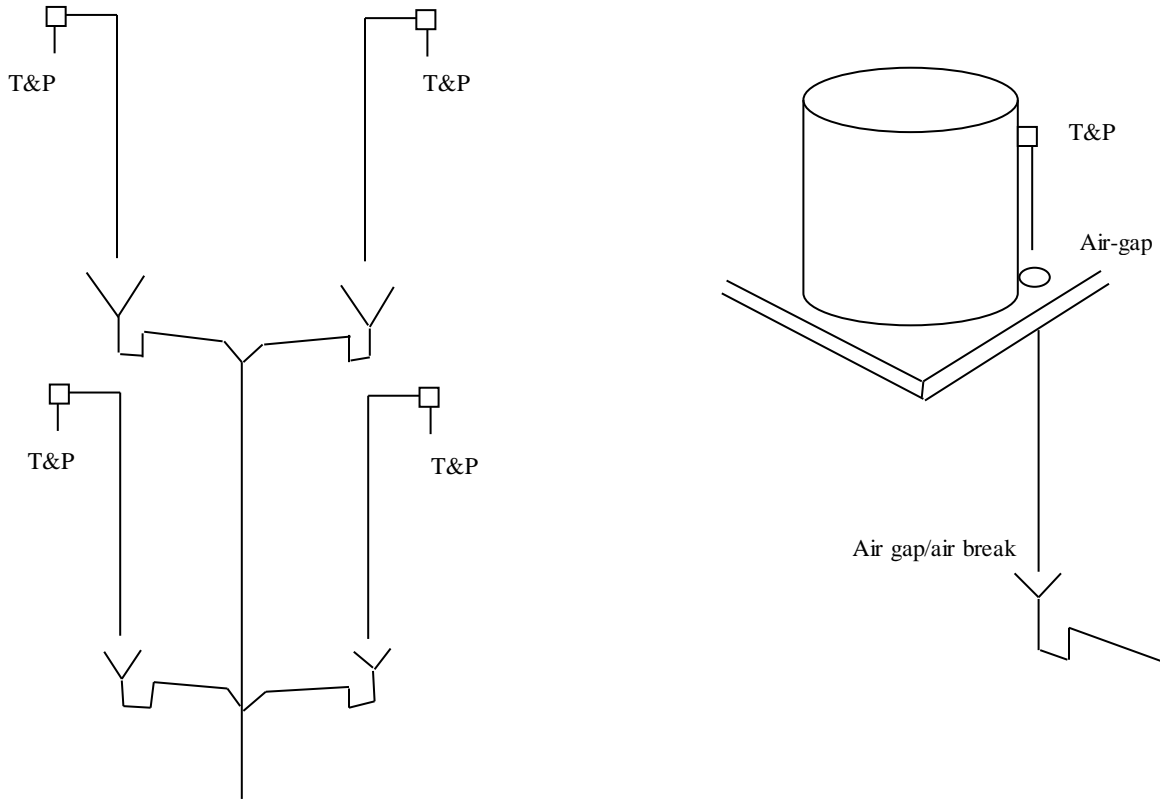

A-82.33 (9) (c) COMMERCIAL GRAVITY DISCHARGE-TYPE CLOTHES WASHERS.

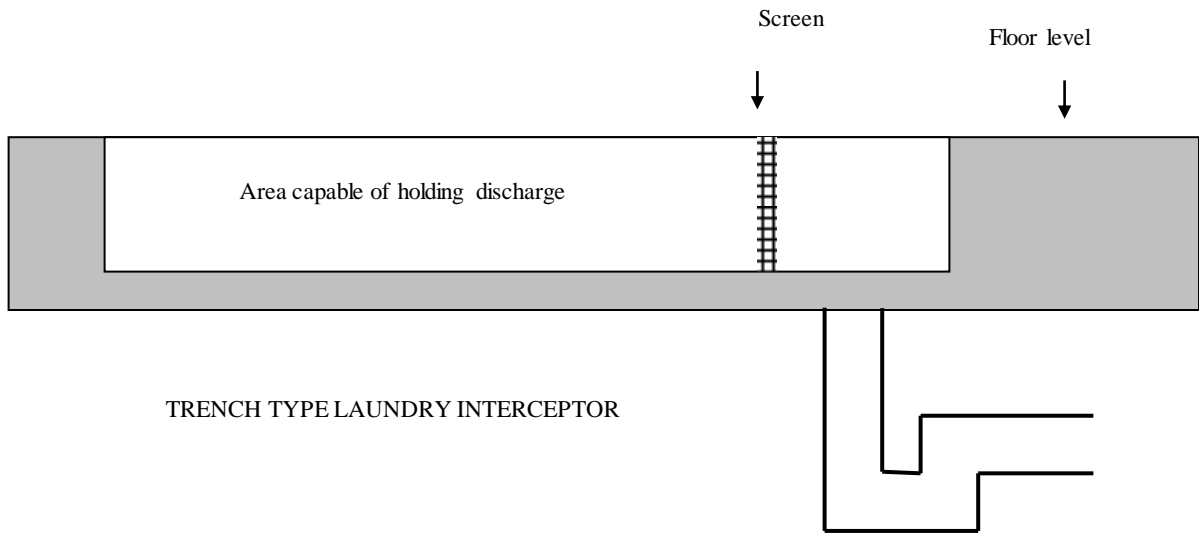

A-82.33 (9) (d)-1. RESIDENTIAL-TYPE CLOTHES WASHERS.

WASHER STANDPIPE RECEPTORS

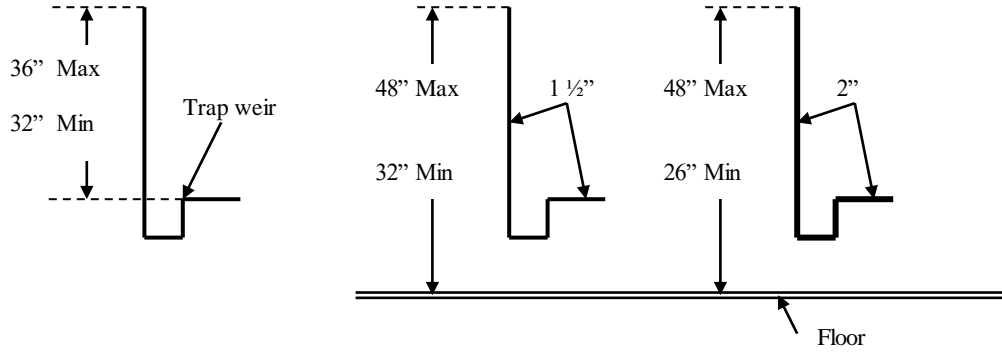

A-82.33 (9) (d)-2. RESIDENTIAL-TYPE DISHWASHERS.

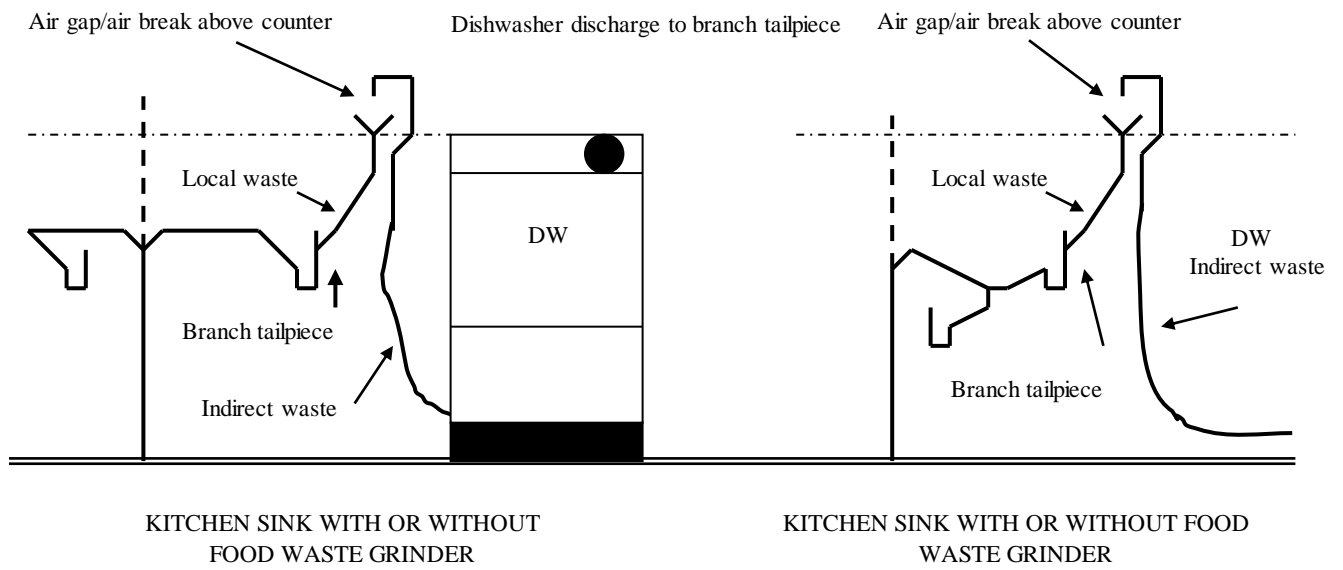

A-82.33 (9) (d)-3. RESIDENTIAL-TYPE DISHWASHERS

Dishwasher discharge to branch tailpiece

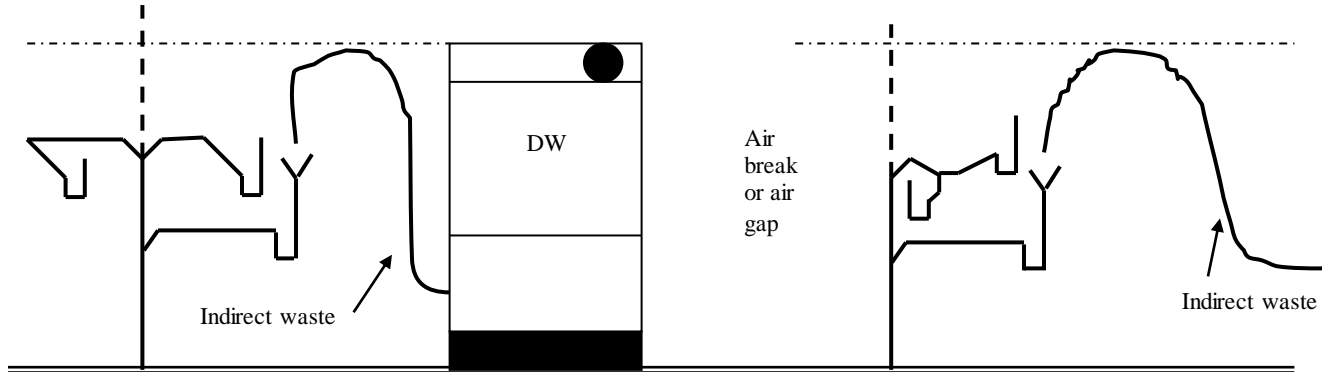

KITCHEN SINK WITH OR WITHOUT
FOOD WASTE GRINDER

A-82.33 (9) (d)-4. COMMERCIAL DISHWASHERS.

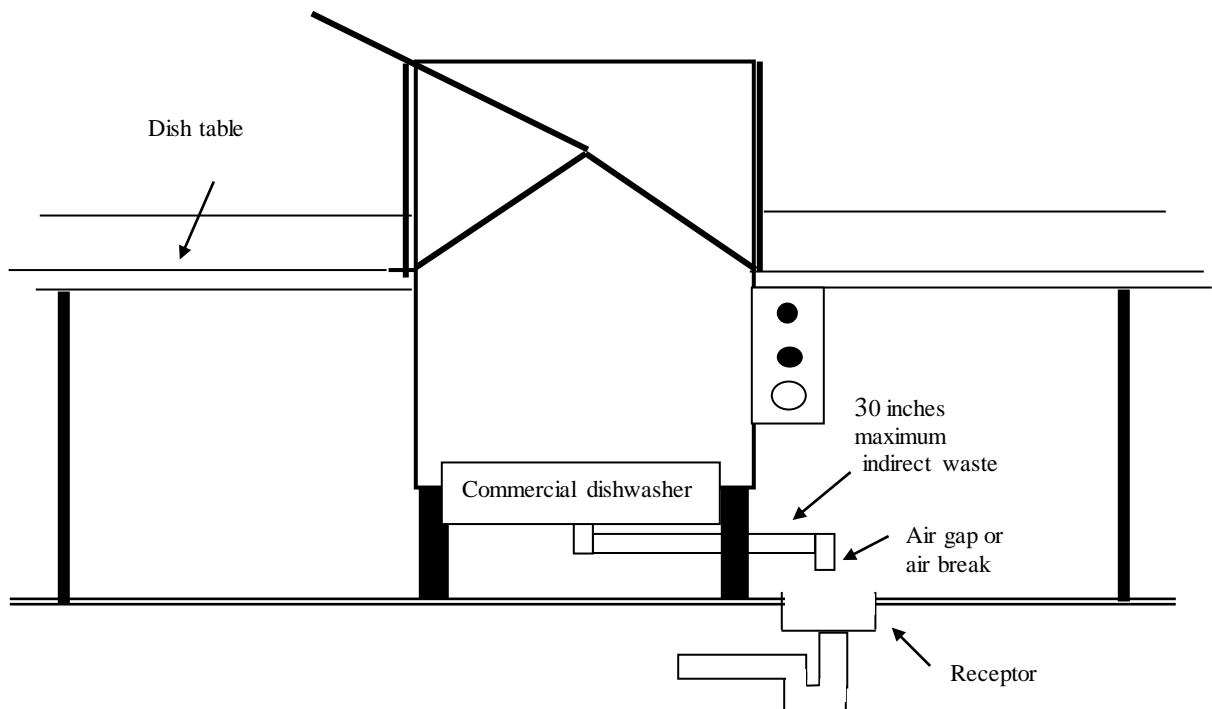

A-82.33 (9) (f)-1. ELEVATOR PIT SUBSOIL AND FLOOR DRAINS. Drains and sumps complying with ss. Comm 82.33 and 82.36 shall be provided.

Note: Section Comm 18.23 includes requirements for the installation of drains and sumps. Section Comm 18.23 reads: "Drains and sumps complying with ss. Comm 82.33 and 82.36 shall be provided. Drains connected directly to sanitary drain systems shall not be installed in elevator pits."

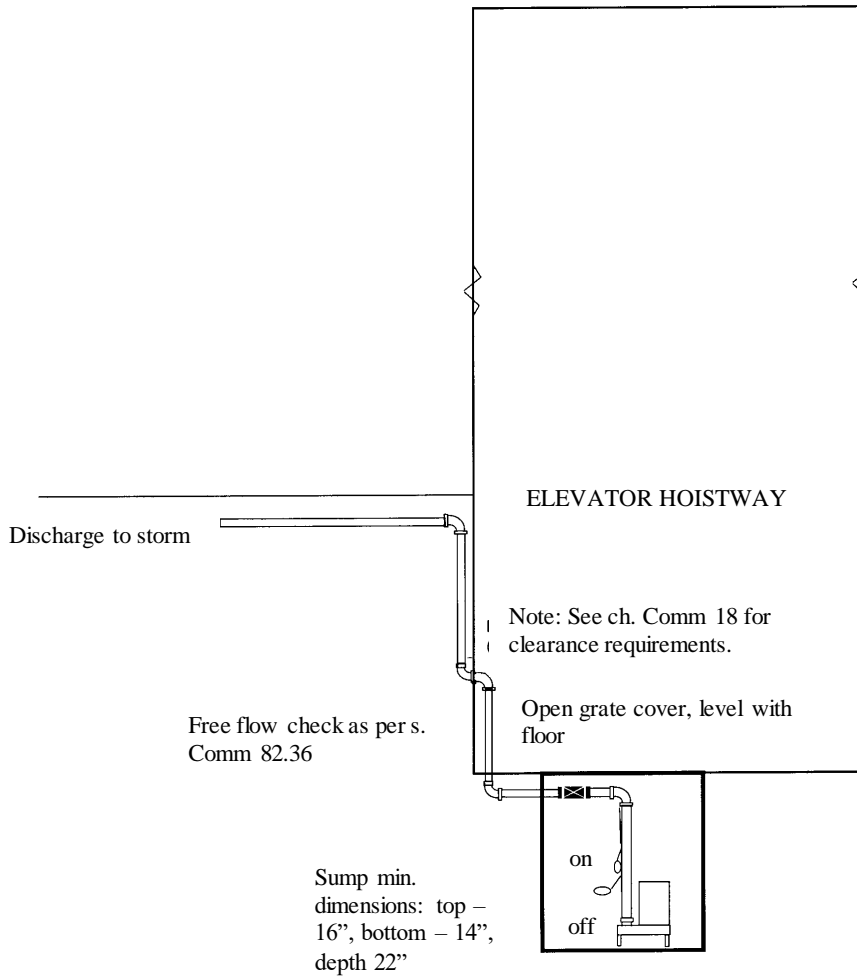

A-82.33 (9) (f)-2. Elevator pit subsoil and floor drains.

ELEVATOR DRAIN DISCHARGE – STORM DRAIN CONNECTION

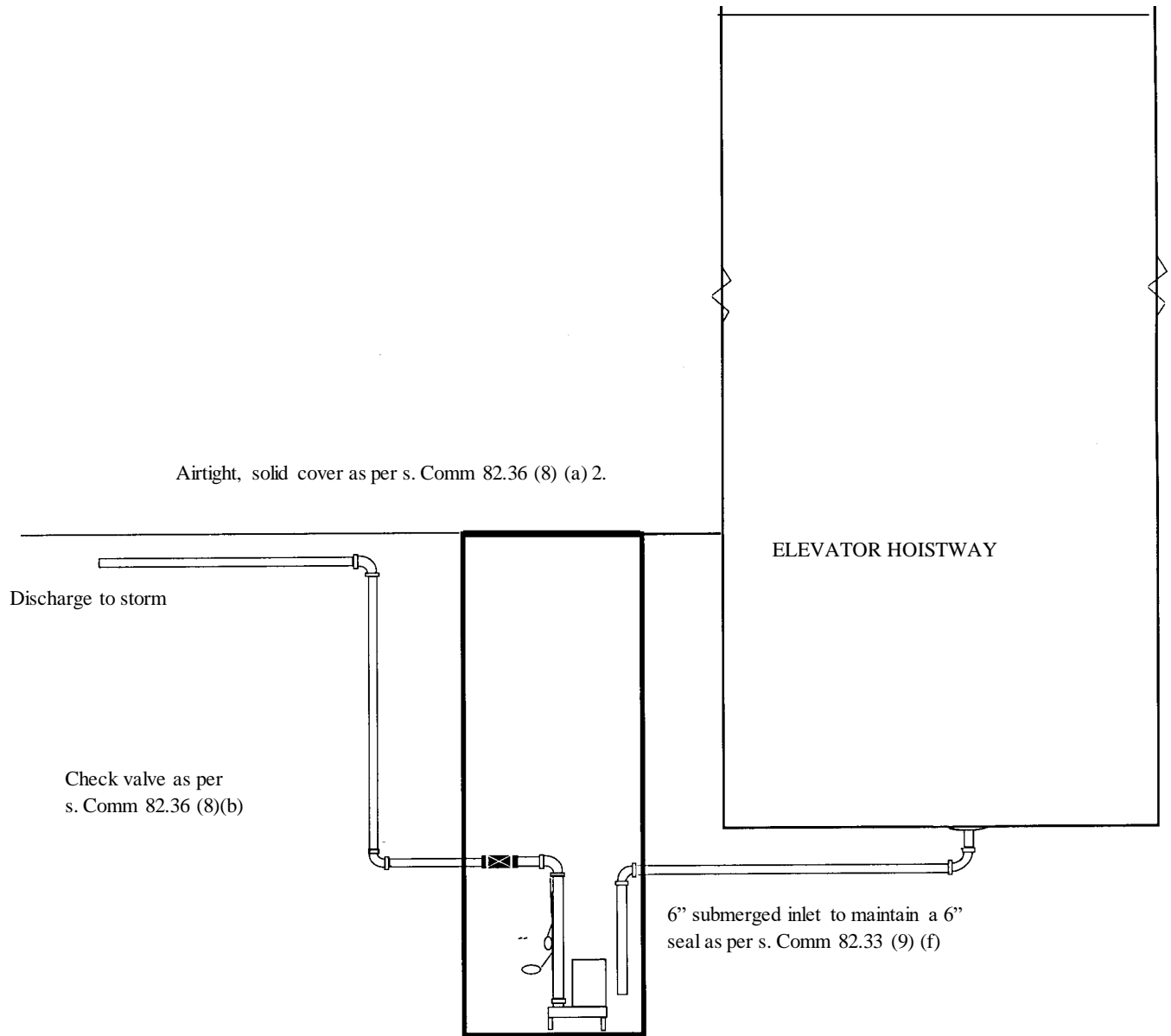

A-82.33 (9) (g) 1. BAR AND SODA FOUNTAIN SINKS.

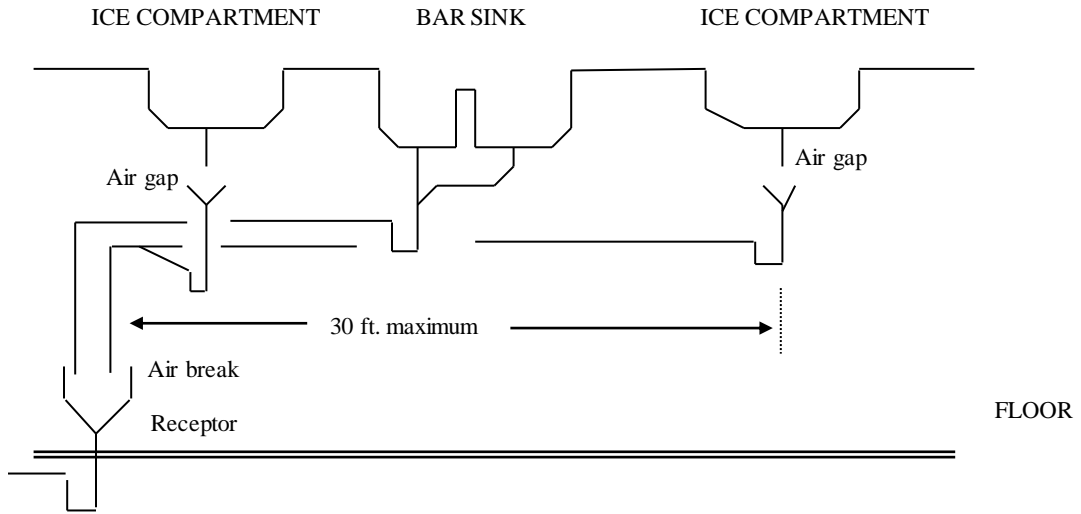

A-82.33 (9) (g) 2. BEER TAPS, COFFEE MAKERS, GLASS FILLERS AND SODA DISPENSERS.

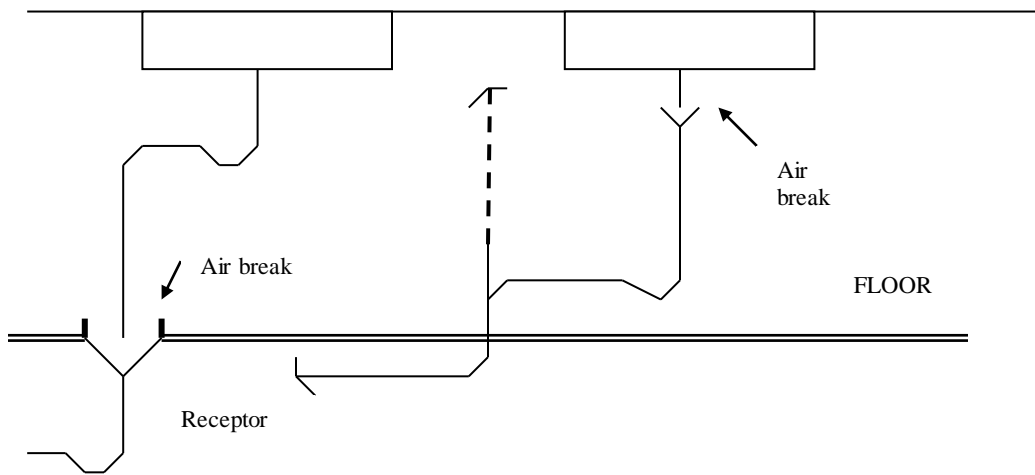

A-82.33 (9) (g) 3. NOVELTY BOXES AND ICE COMPARTMENTS AND ICE CREAM DIPPER WELLS.

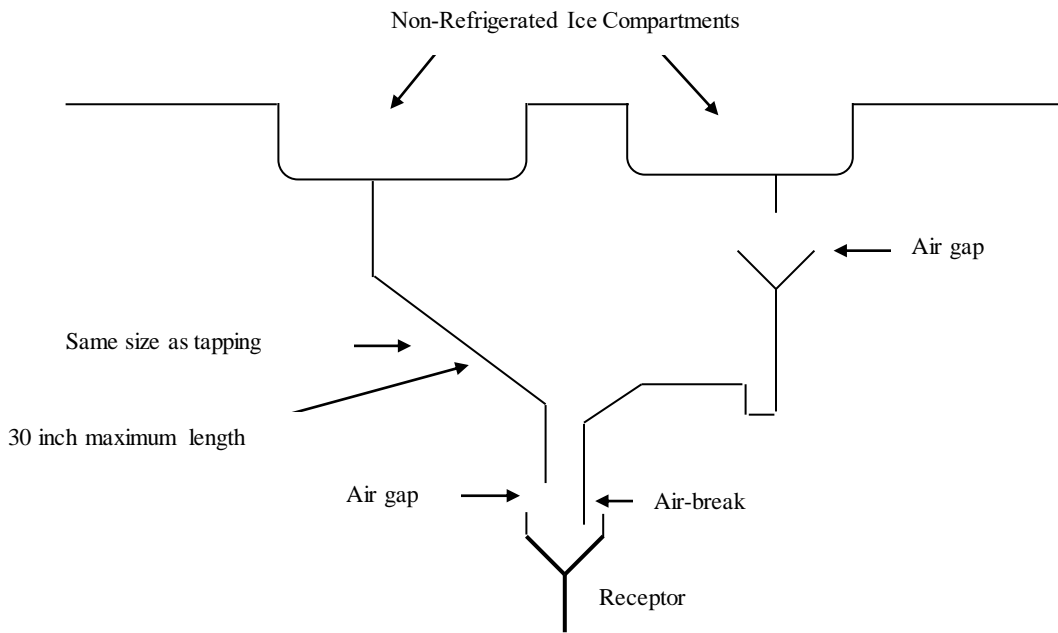
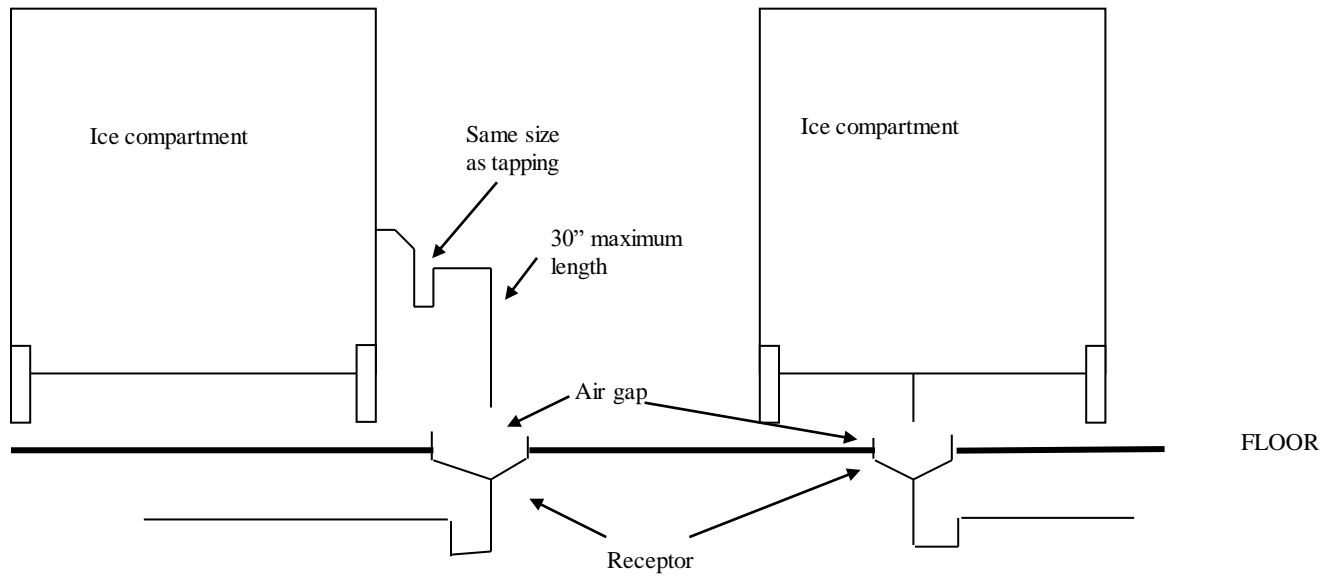

A-82.33 (9) (g) 4. REFRIGERATED FOOD STORAGE ROOMS, COMPARTMENTS AND DISPLAY CASES.

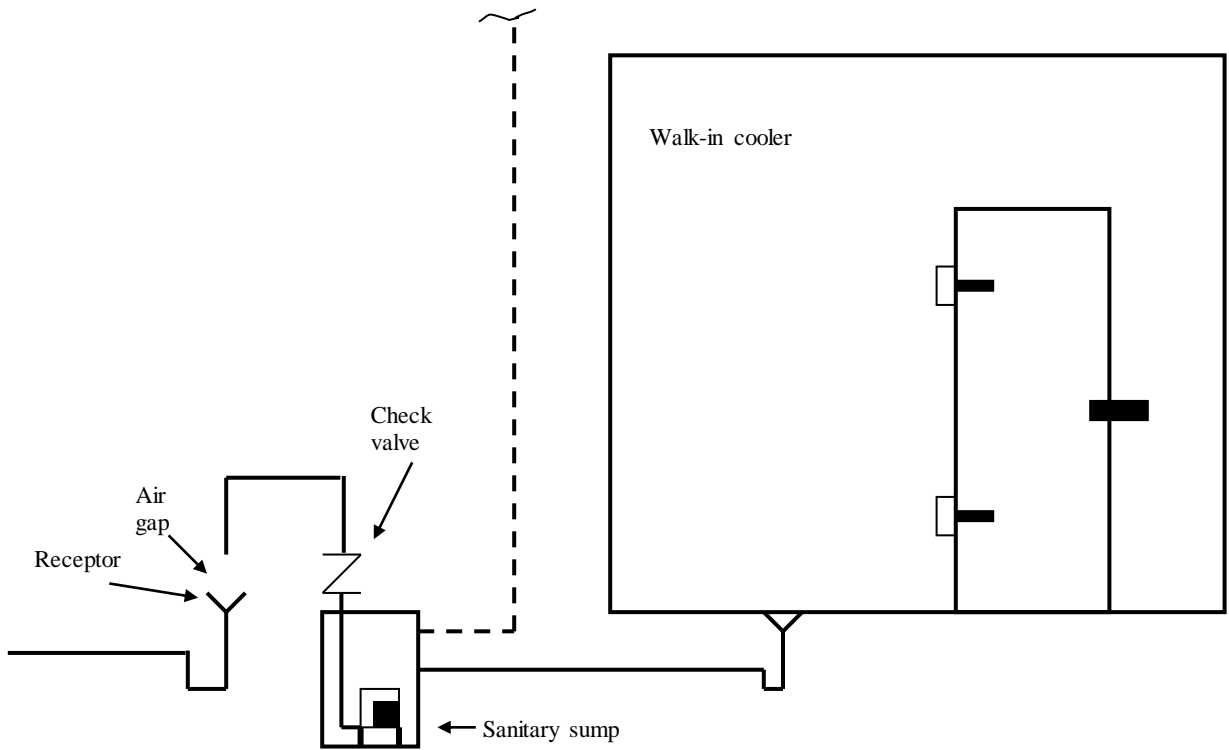
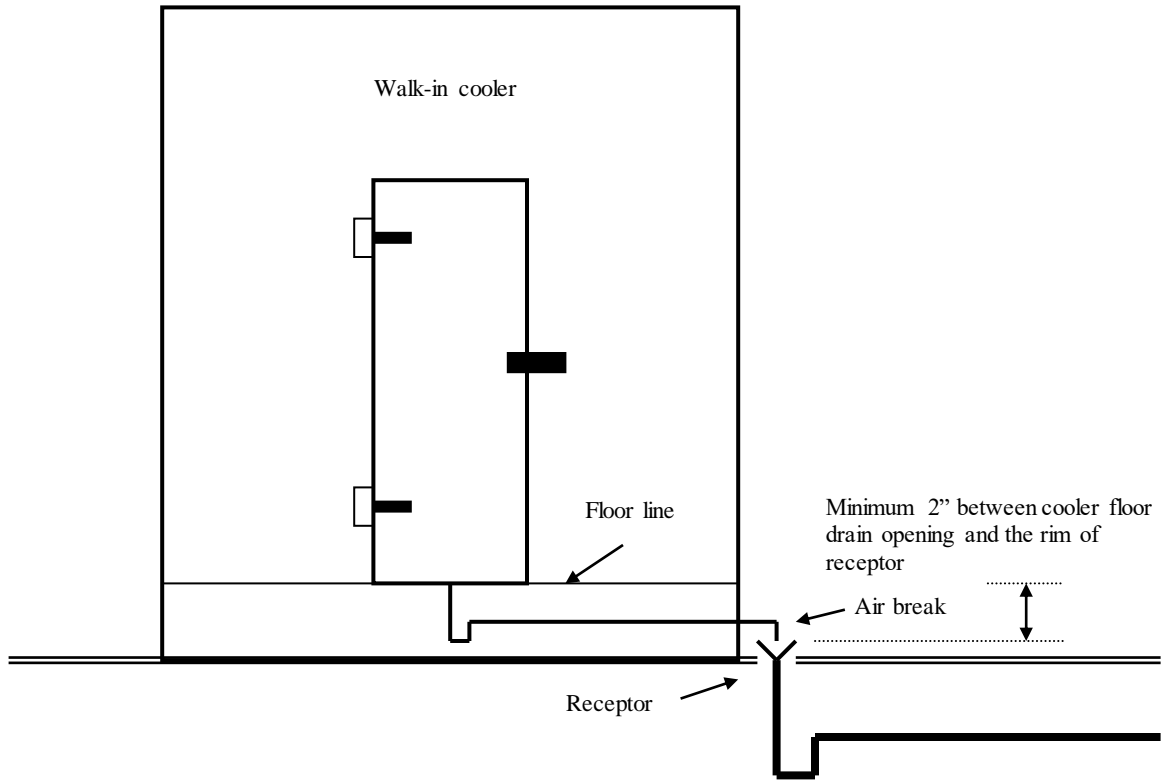

A-82.33(9) (g) 5. MISCELLANEOUS FOOD HANDLING EQUIPMENT.

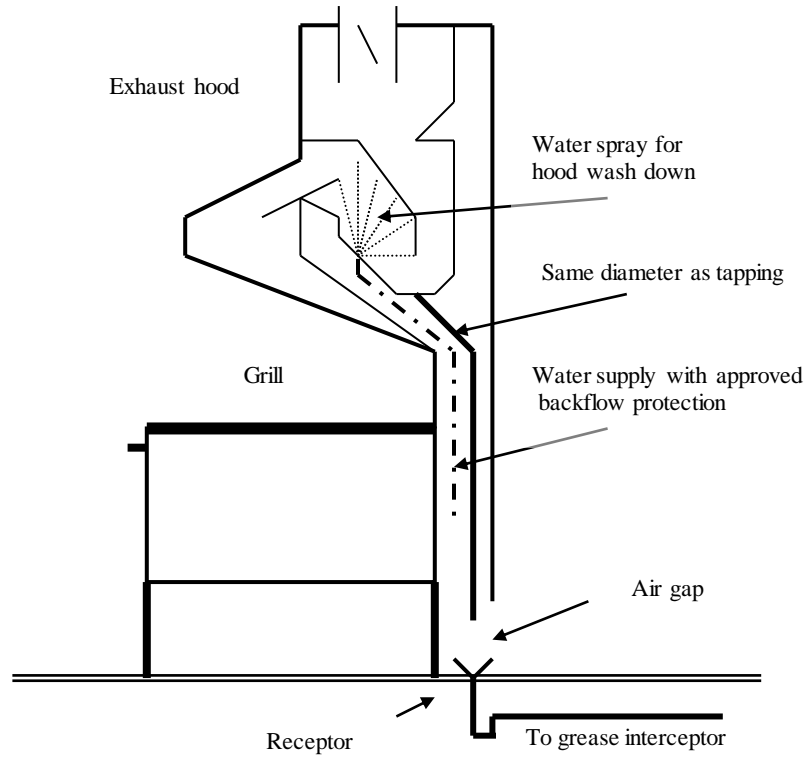

A-82.33(9) (g) 5. MISCELLANEOUS FOOD HANDLING EQUIPMENT.

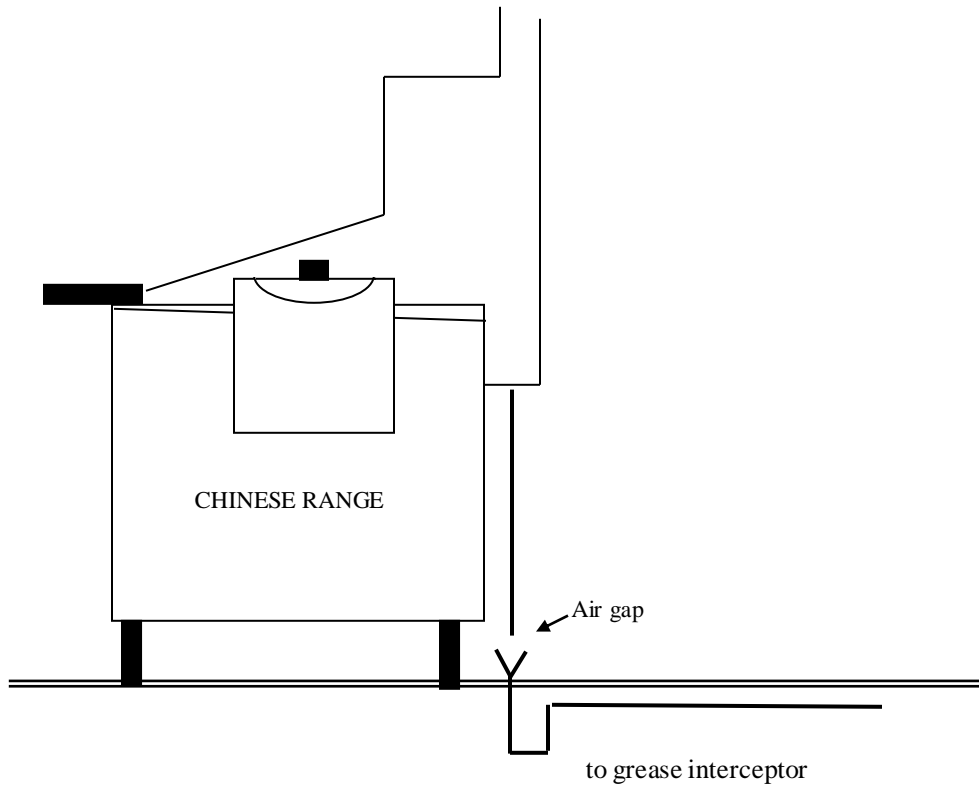

A-82.34 (4)-1. GARAGE CATCH BASINS.

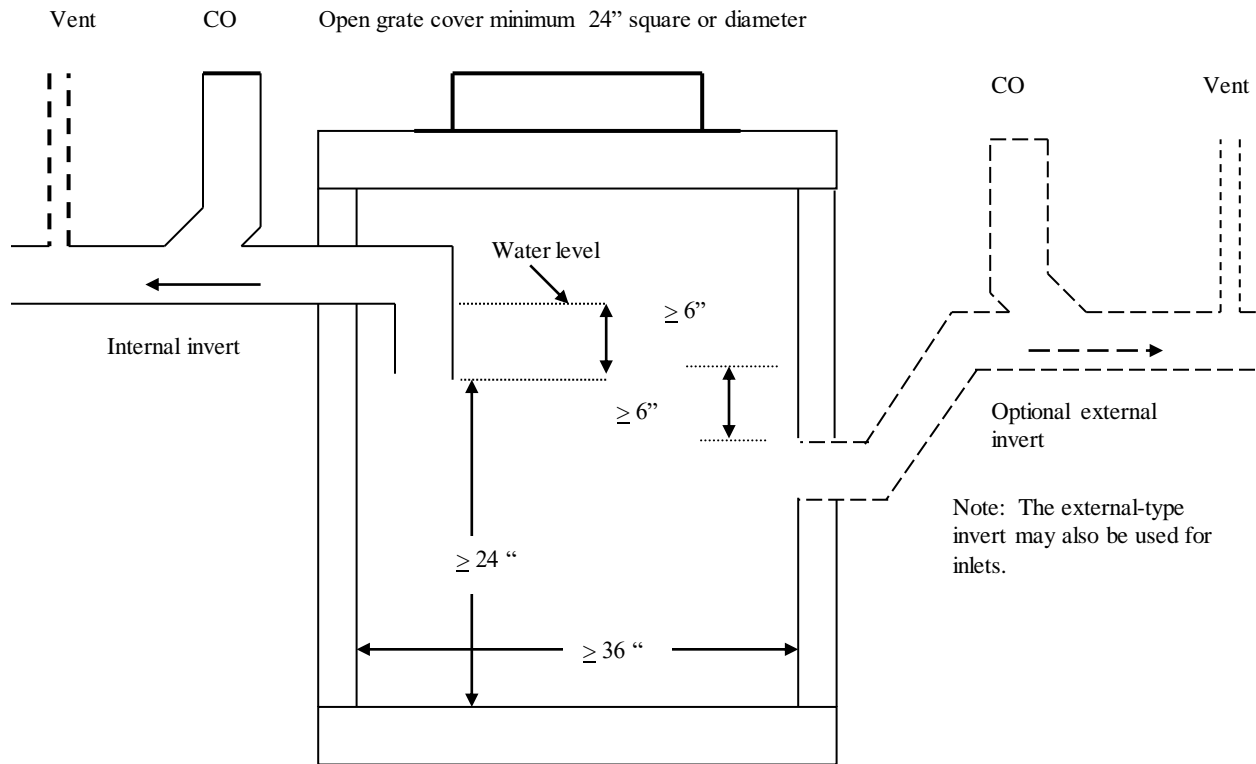

A-82.34 (4)-2. TRAPPED FIXTURES DISCHARGING TO CATCH BASIN.

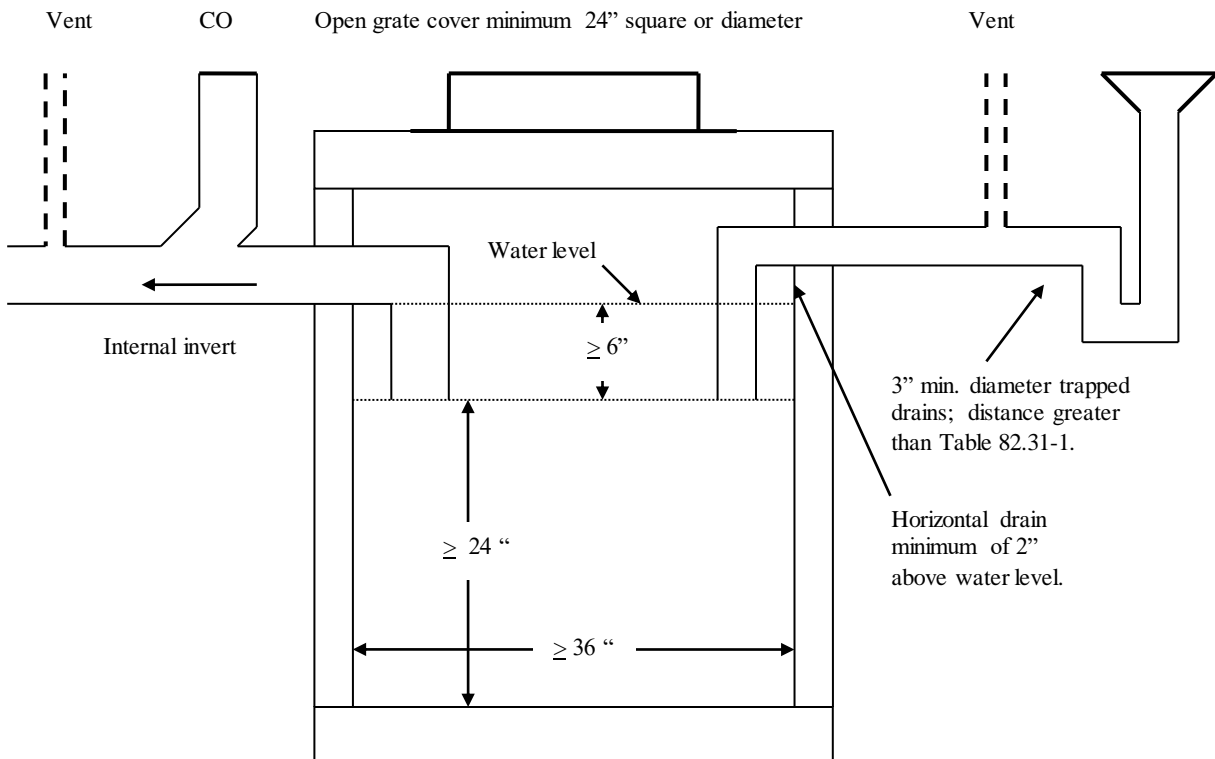

A-82.34 (4)-3. TRAPPED FIXTURE DISCHARGING INTO GARAGE CATCH BASIN.

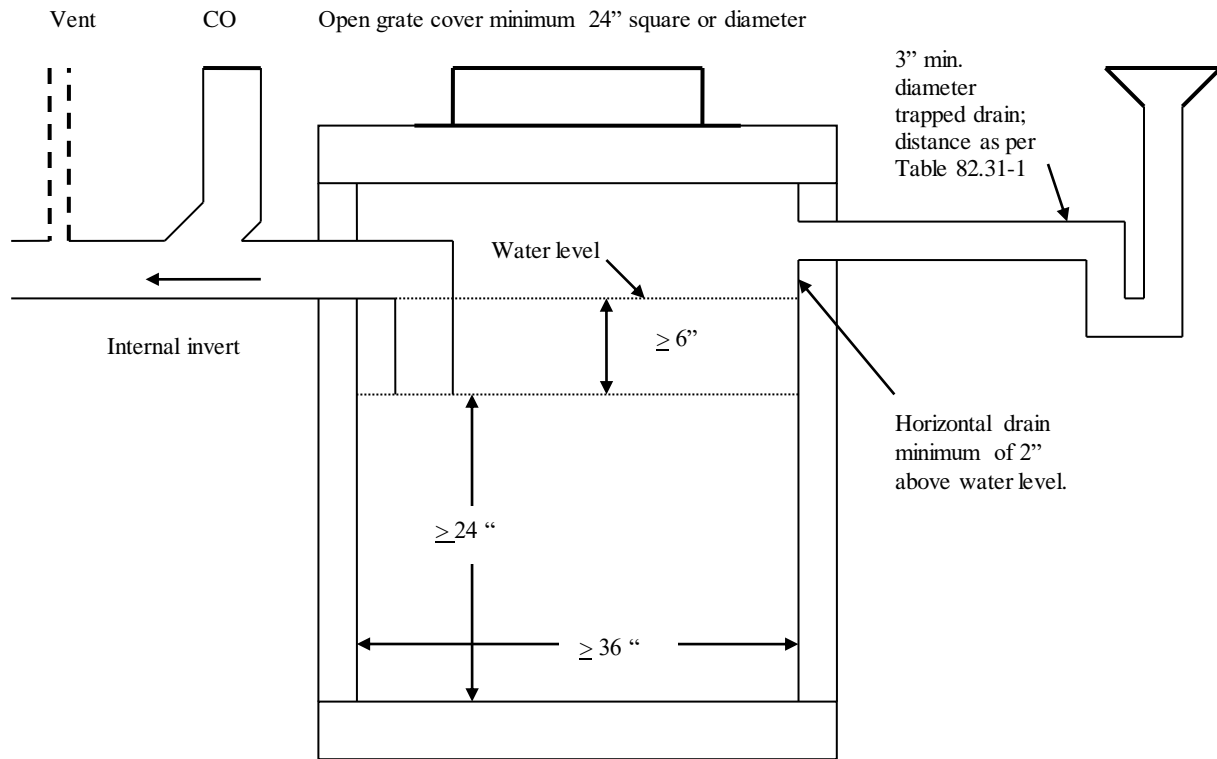

A-82.34 (4)-4. FIXTURES WITHOUT TRAPS DISCHARGING TO CATCH BASIN.

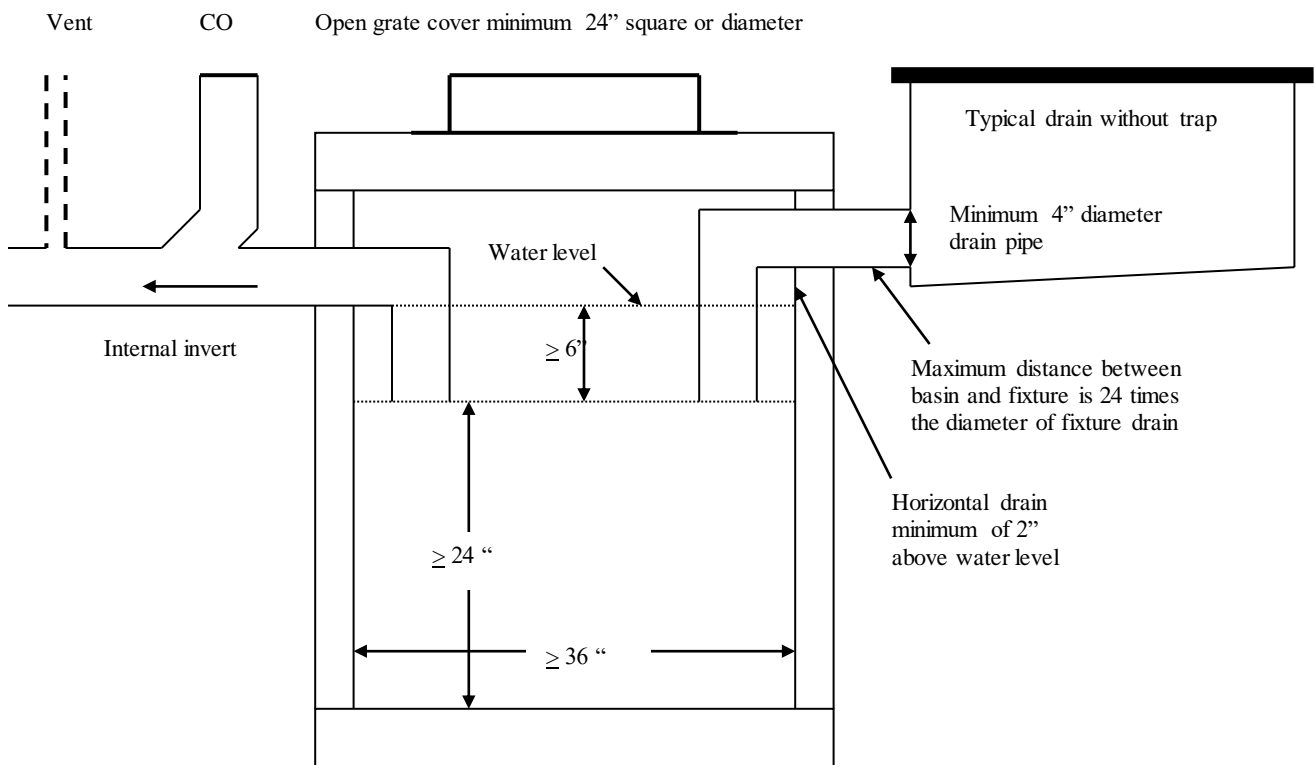

A-82.34 (4)-5. GARAGE CATCH BASIN WITH FIXTURES ON SEPARATE FLOOR LEVELS.

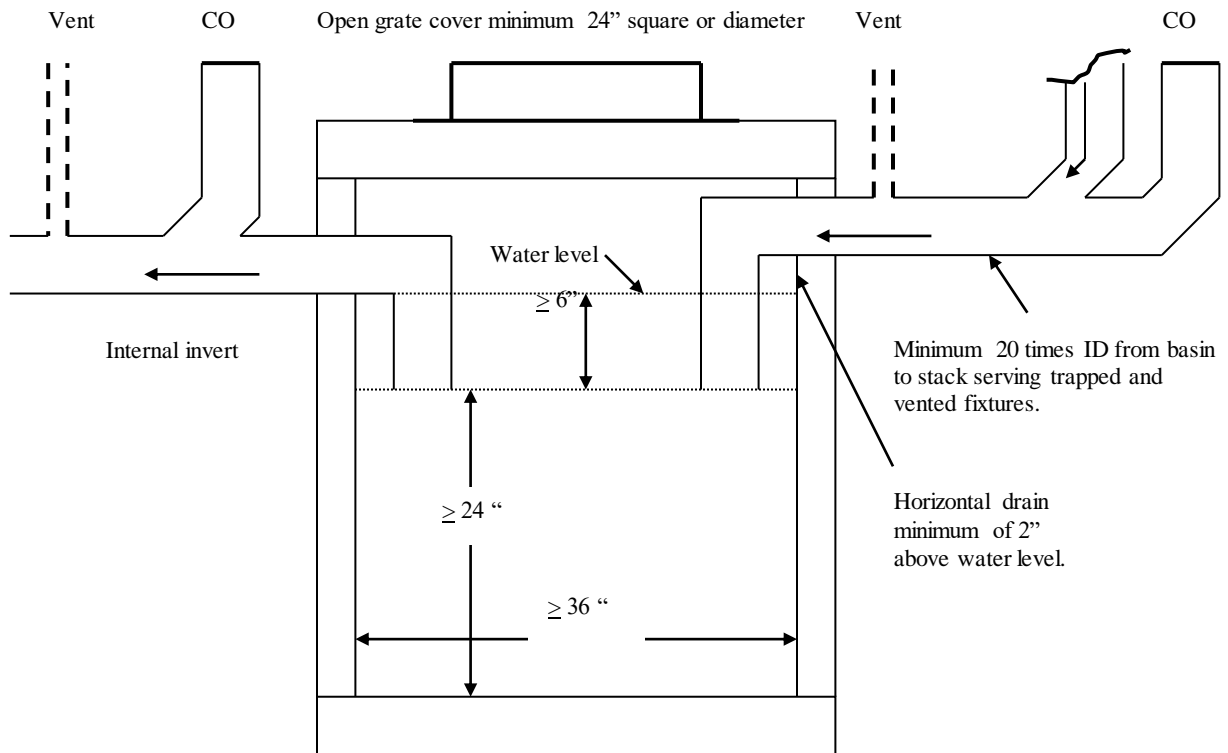

A-82.34 (4)-6. GARAGE CATCH BASIN RECEIVING PRESSURIZED DRAINS.

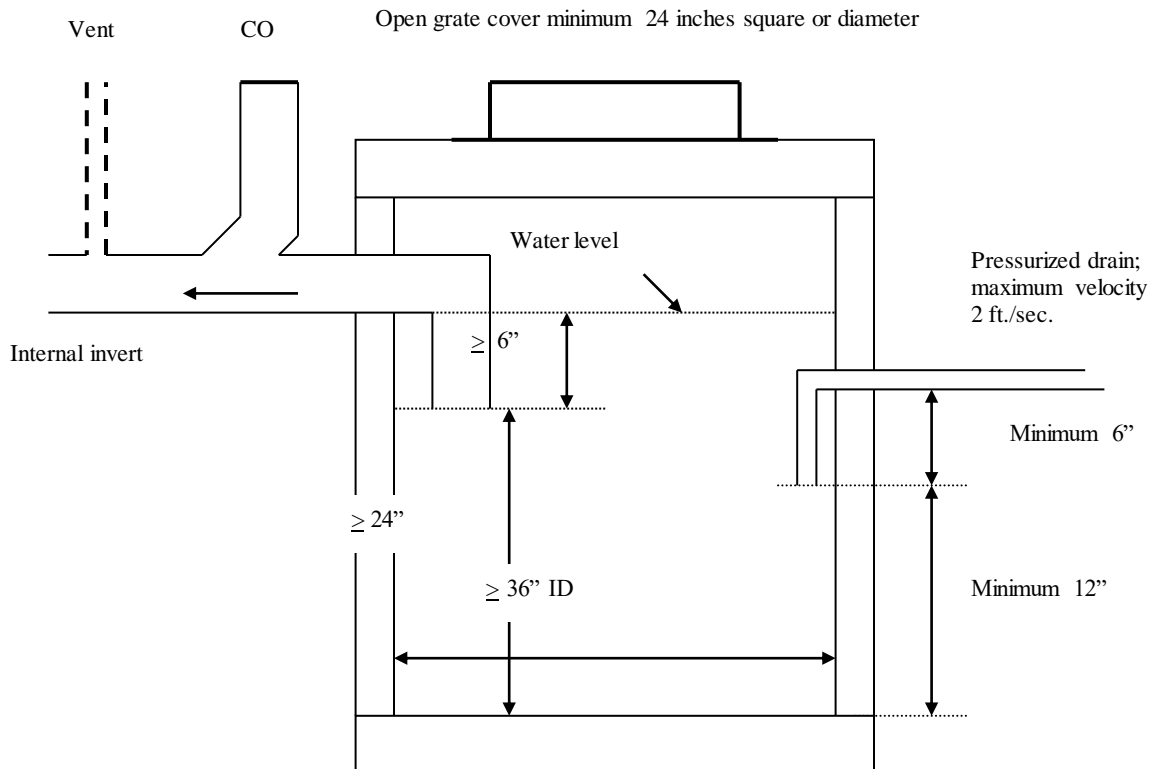

A-82.34 (5) (b)-1. EXTERIOR GREASE INTERCEPTORS.

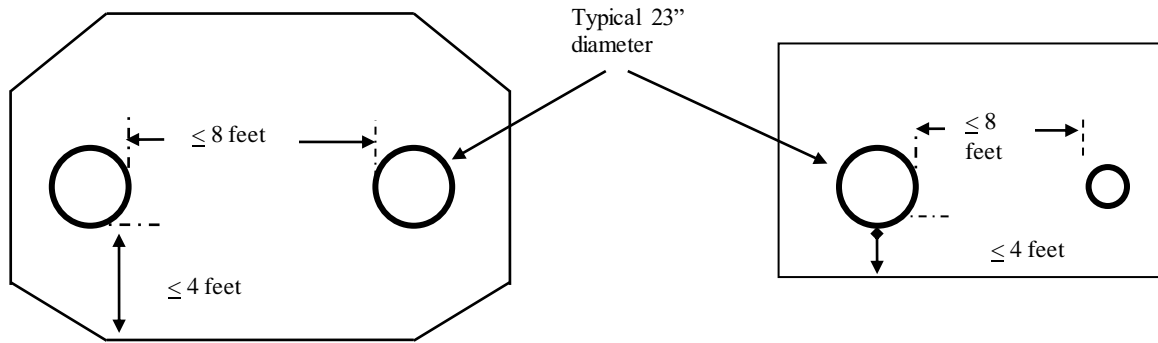

GREASE INTERCEPTOR MANHOLE LOCATION

A-82.34 (5) (b)-2. EXTERIOR GREASE INTERCEPTORS.

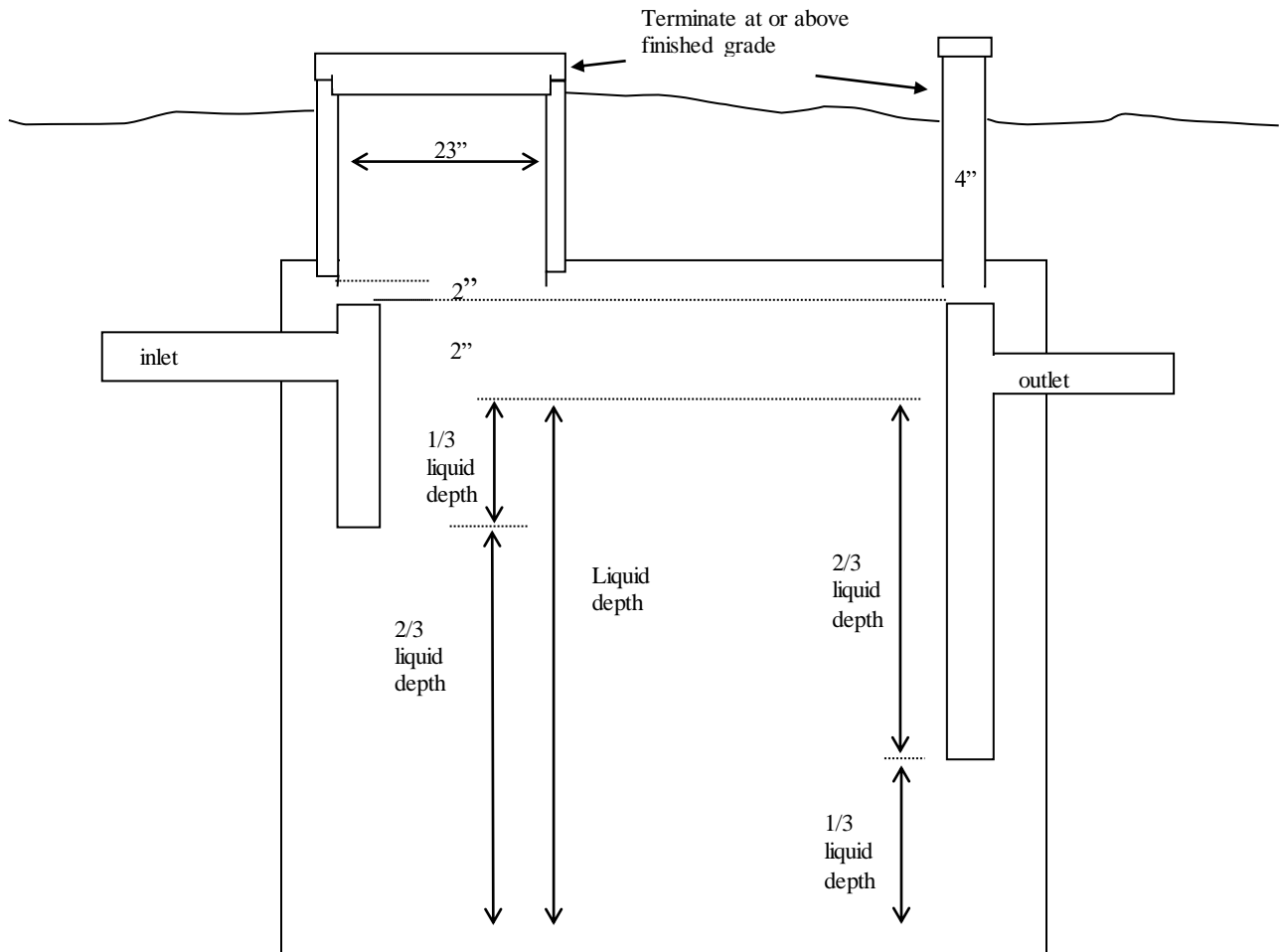

A-82.34 (5) (c) INTERIOR GREASE INTERCEPTORS.

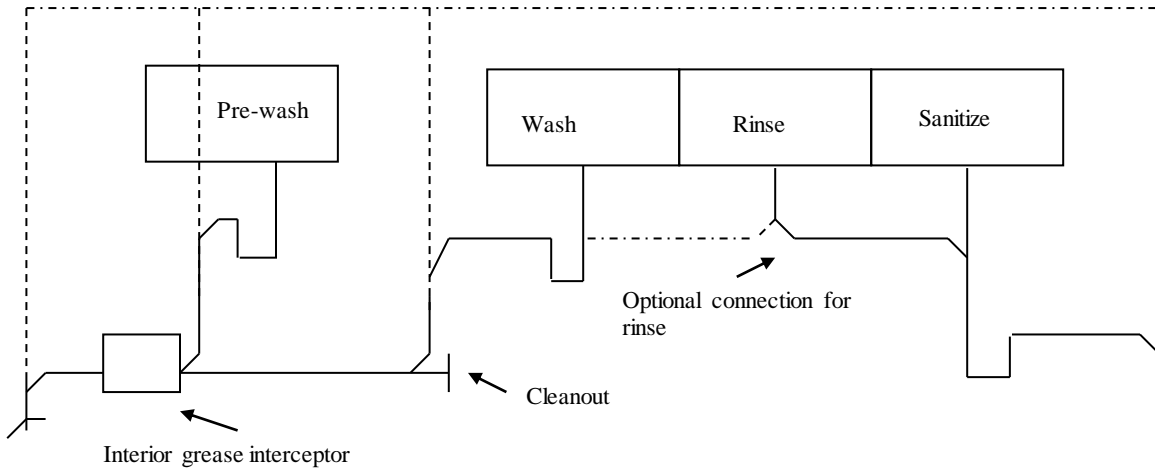

PRE-WASH AND 3-COMPARTMENT SCULLERY SINK

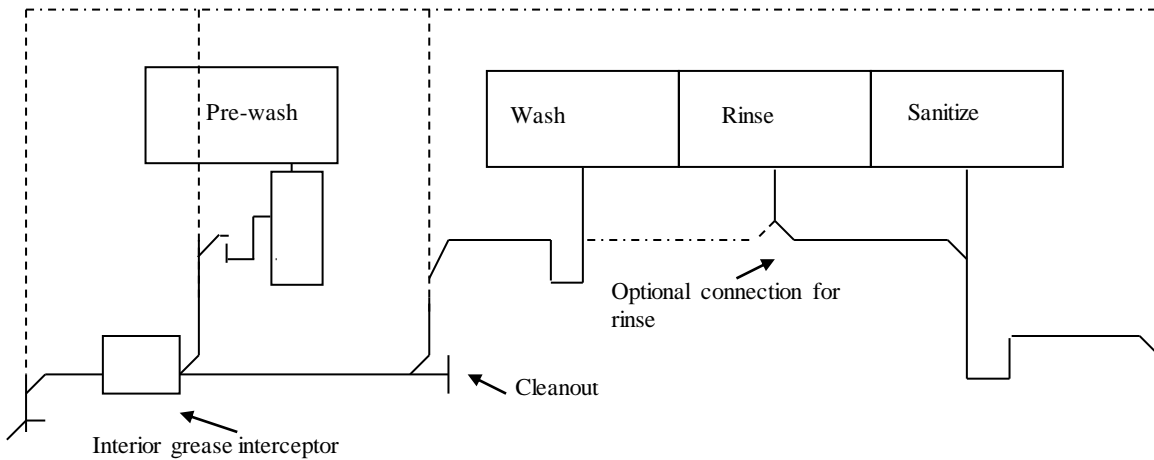

PRE-WASH WITH DISPOSAL AND 3- COMPARTMENT SCULLERY SINK

A-82.34 (6) AUTOMATIC CAR WASHES.

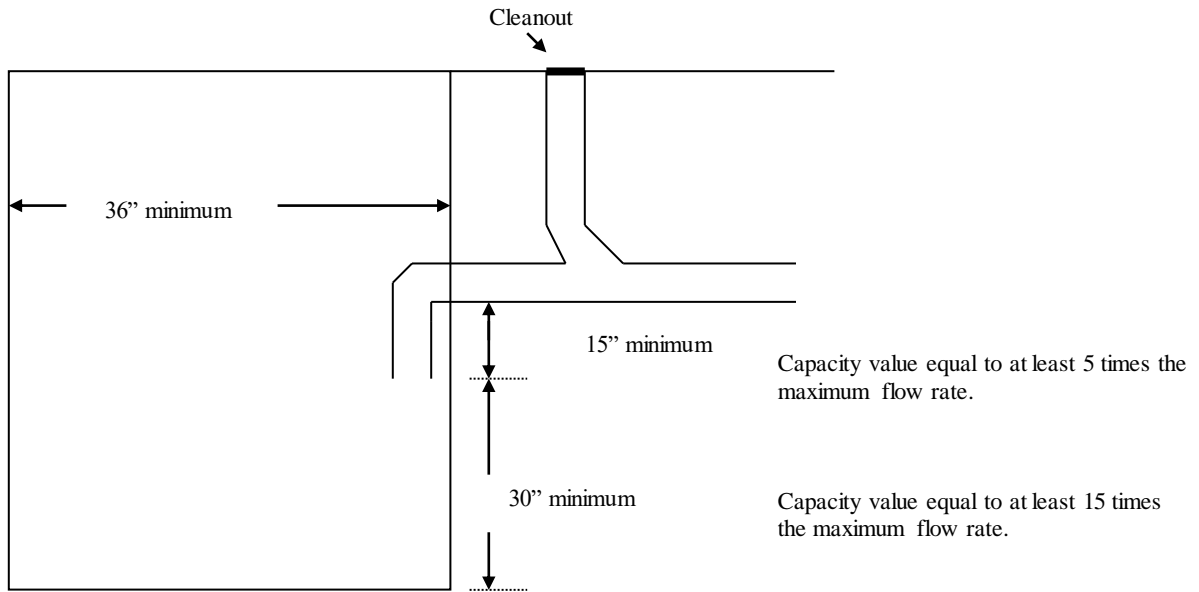

CAR WASH INTERIOR WITH INVERT INSIDE OF BASIN

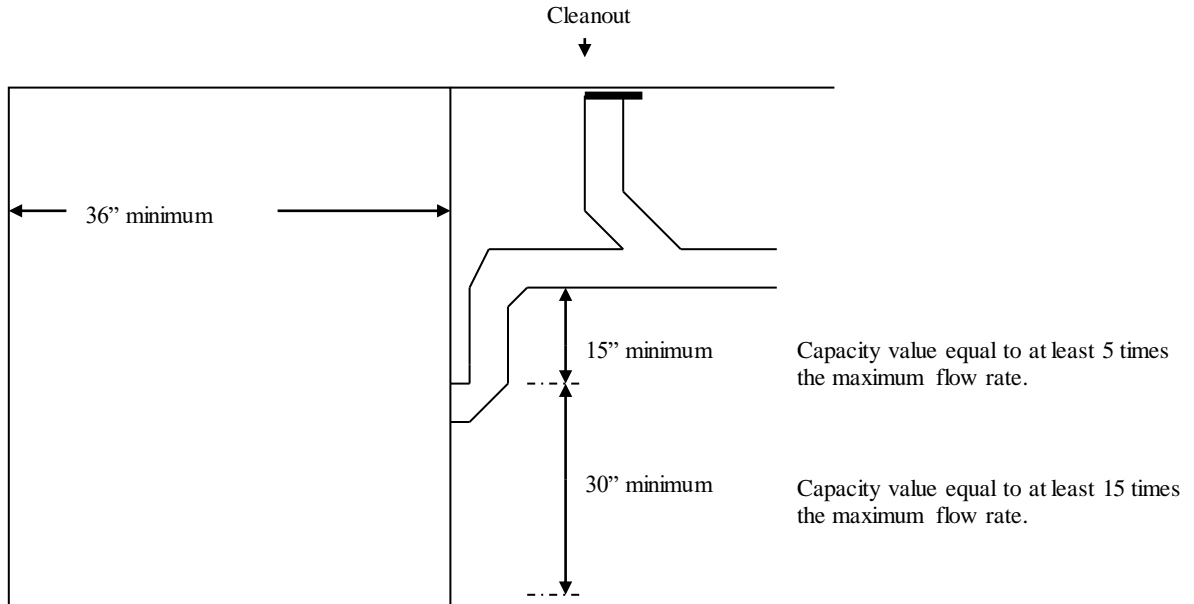

CAR WASH INTERIOR WITH INVERT OUTSIDE OF BASIN

A-82.34 (7) COMMERCIAL LAUNDRIES.

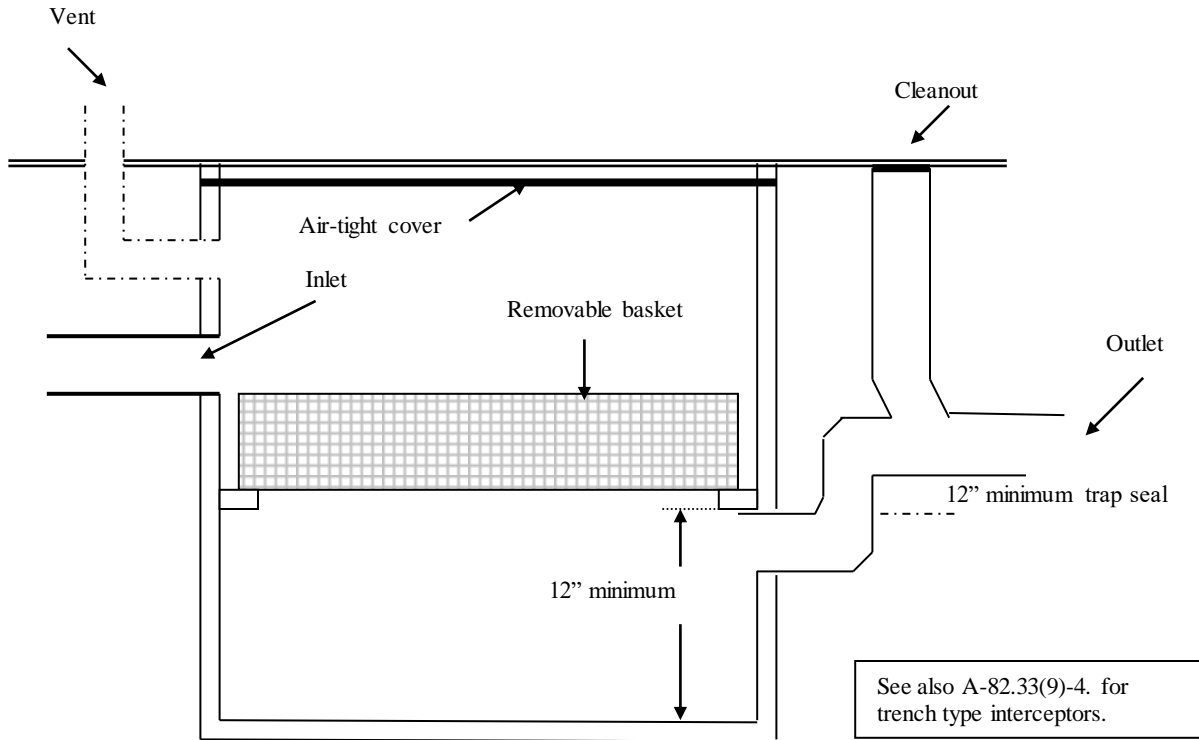

IN LINE LAUNDRY INTERCEPTOR

A-82.34 (8) OIL AND FLAMMABLE LIQUIDS INTERCEPTOR.

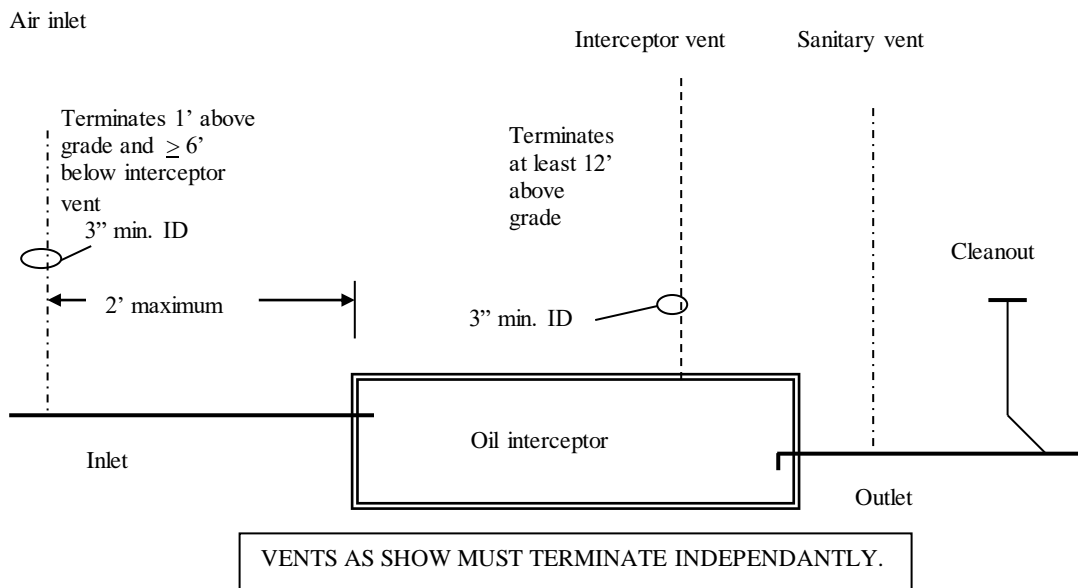

VENTS AS SHOW MUST TERMINATE INDEPENDANTLY.

A-82.34 (13) PLASTER AND HEAVY SOLIDS TRAP TYPE INTERCEPTORS.

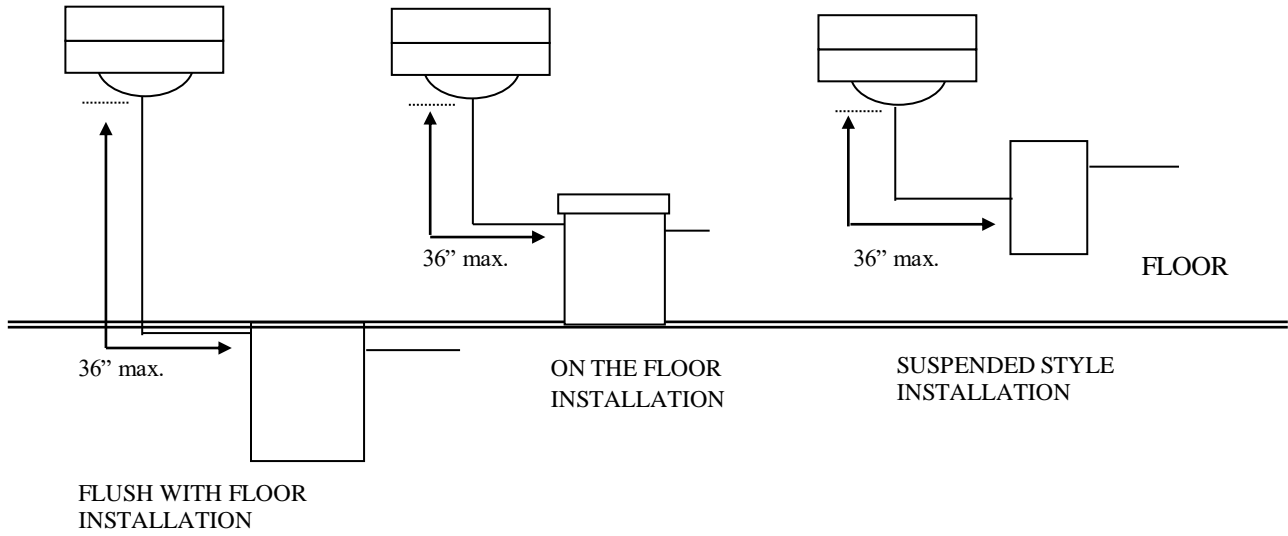

A-82.34 (14) CHEMICAL DILUTION AND NEUTRALIZING BASINS.

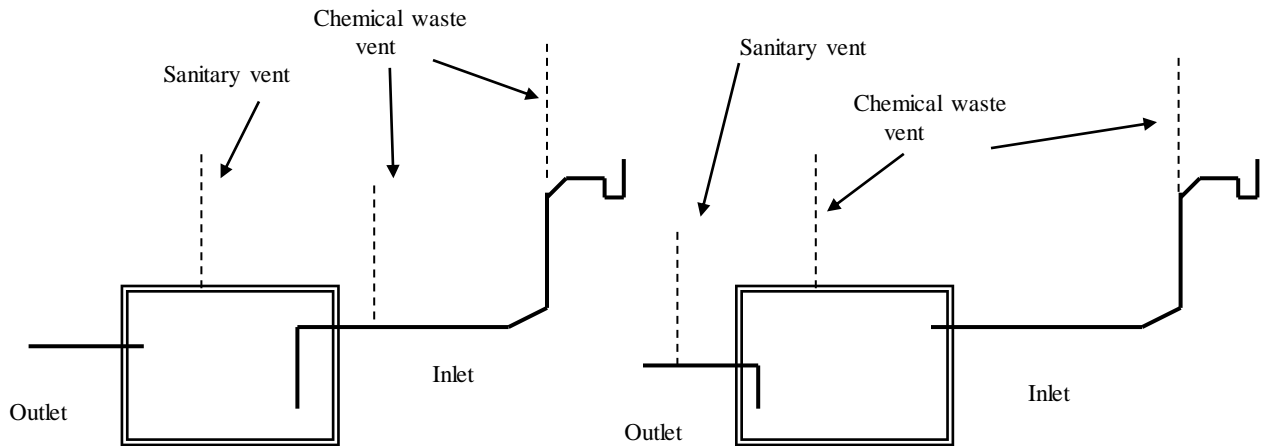

A-82.35 (3) CLEANOUTS SERVING HORIZONTAL DRAINS WITHIN OR UNDER A BUILDING.

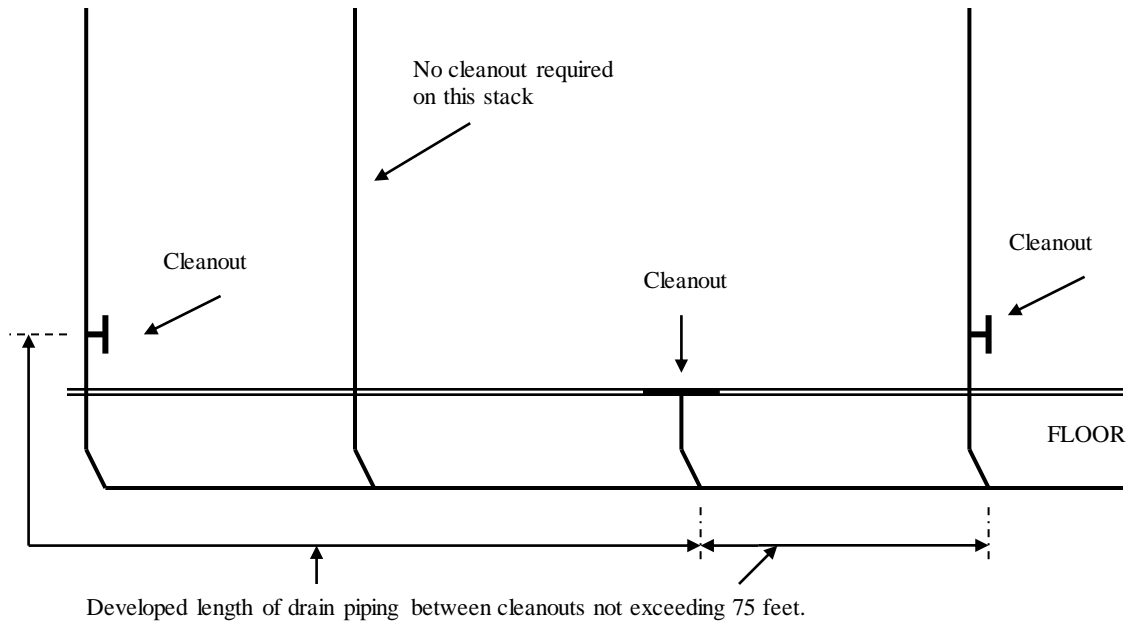

A-82.35 (5) (a) CLEANOUT EXTENSION TO GRADE.

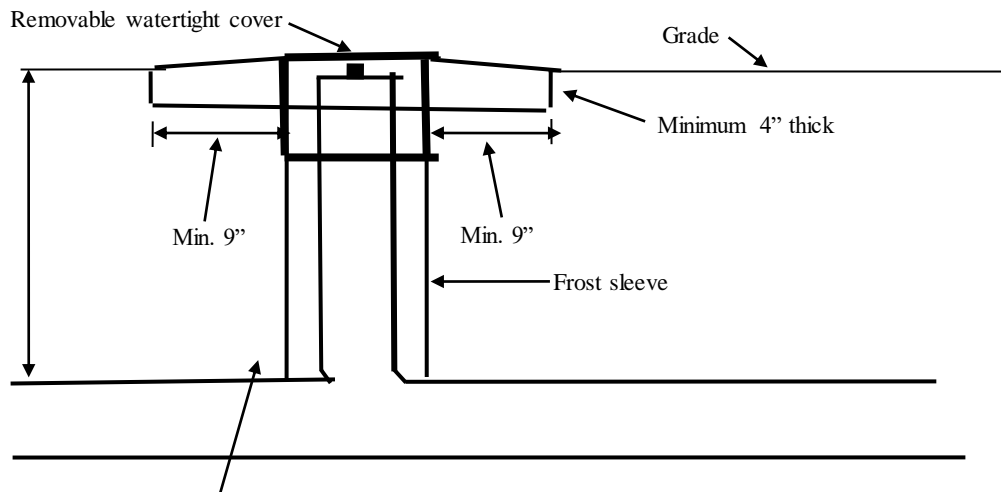
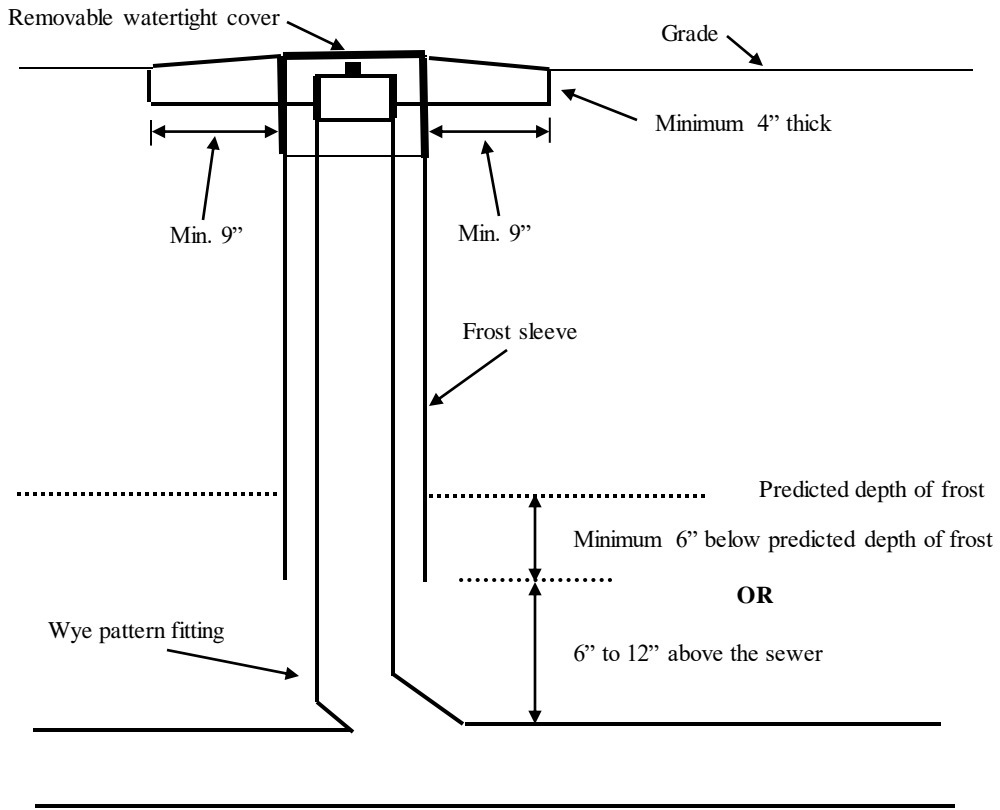

If depth is 18'' or less, this may be a sanitary pattern fitting.

A-82.35 (8) OUTSIDE DROP INTO AN EXISTING MANHOLE.

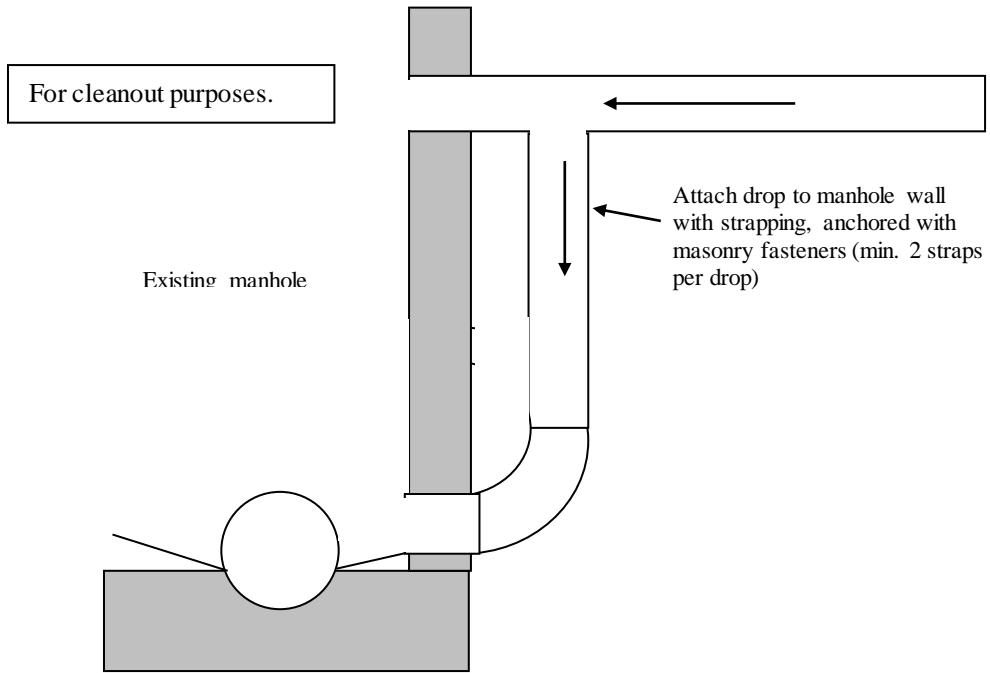

A-82.36 (3) SOURCES OF POLLUTANTS IN WISCONSIN STORMWATER.

Sources of Pollutants in Wisconsin Stormwater^a
Geometric Mean Concentrations of Contaminants in Runoff from Source-Area and Storm-Sewer Outfalls

Contaminant	Feeder Streets	Collector Streets	Arterial Streets	Lawns	Drive-ways	Roofs	Parking Lots	Outfall
Residential Source Areas								
Total Solids (mg/L)	796	493	-	600	306	91	-	369
Suspended Solids (mg/L)	662	326	-	397	173	27	-	262
Total Phosphorus (mg/L)	1.31	1/07	-	2.67	1.16	.15	-	.66
Total Recoverable Copper (µg/L)	24	56	-	13	17	15	-	16
Total Recoverable Lead (µg/L)	33	55	-	--	17	21	-	32
Total Recoverable Zinc (µg/L)	220	339	-	59	107	149	-	203
Fecal Coliform (cfu/100mL)	92,061	56,554	-	42,093	34,294	294	0	175,106
Commercial Source Areas								
Total Solids (mg/L)	-	---	373	-	-	112	127	---
Suspended Solids (mg/L)	-	---	232	-	-	15	58	---
Total Phosphorus (mg/L)	-	---	.47	-	-	.20	.19	---
Total Recoverable Copper (µg/L)	-	---	46	-	-	9	15	---
Total Recoverable Lead (µg/L)	-	---	50	-	-	9	22	---
Total Recoverable Zinc (µg/L)	-	---	508	-	-	330	178	---
Fecal Coliform (cfu/100mL)	-	---	9,627	-	-	1,117	1,758	---
Industrial Source Areas								
Total Solids (mg/L)	-	958	879	---	-	78	531	267
Suspended Solids (mg/L)	-	763	690	---	-	41	312	146
Total Phosphorus (mg/L)	-	1.5	.94	---	-	.11	.39	.34
Total Recoverable Copper (µg/L)	-	76	74	---	-	6	41	28
Total Recoverable Lead (µg/L)	-	86	60	---	-	8	38	25
Total Recoverable Zinc (µg/L)	-	479	575	---	-	1,155	304	265
Fecal Coliform (cfu/100mL)	-	8,338	4,587	---	-	144	2,705	5,114

Note: Single dash indicates source area is not in the land use; double dash indicates insufficient data; triple dash indicates values are shared with those above for the same source area; The relatively large concentrations of zinc in roof runoff indicate that galvanized roofing materials were a source of the zinc. One-third of the residential roofs had galvanized downspouts. Roofing materials also might be a source of copper and lead in the runoff from residential roofs. Concentrations of dissolved copper and total recoverable copper and lead were slightly larger in the residential roof runoff than in runoff from driveways and lawns.

Note: The department has accepted that a “visible sheen” is defined as 15 mg/L grease and oil.

^a Source: Bannerman, R.T.; Owens D.W.; Dodds, R.B.; and Hornewer, N.J., 1993, Sources of Pollutants in Wisconsin Stormwater: Water Science Technology, v.28, no. 3-5, p. 241-259.

A-82.36 (3)–1. BEST MANAGEMENT PRACTICES (BMPs). A description of the proposed best management practices to be used for stormwater management in the protection of water quality include, but are not limited to, the following:

- a. Detention, retention and sedimentation facilities, including plans for discharges from the facilities, maintenance plans and predictions of water quality.
- b. Areas of the site to be used or reserved for infiltration including a prediction of the impact on groundwater quality.
- c. Any other relevant volume controls or measures.
- d. Any other relevant source control practices not described.
- e. Any treatment device, including plans for discharges from the facilities, maintenance plans and predictions of water quality.

Note: Section NR 151.002 (4) reads: “Best management practices” or “BMPs” means structural or non-structural measures, practices, techniques or devices employed to avoid or minimize soil, sediment or pollutants carried in runoff to waters of the state.’

A-82.36 (4)-1. RATIONAL METHOD. The equation procedure for using the rational method formula.

$$Q = Aci \text{ (in cubic feet per second)}$$

Where: Q = Runoff (in cubic feet per second)
A = Drainage area (in acres)
c = Coefficient of runoff (a dimensionless number)
i = Intensity of rainfall (in inches per hour)

$$Q = (0.0104)ciA \text{ (in gallons per minute)}$$
$$(1/96)ciA$$

Where: Q = Runoff (in gallons per minute)
c = Coefficient of runoff (a dimensionless number)
i = Intensity of rainfall (in inches per hour)
A = Drainage area (in square feet)

A-82.36 (4)-2. RUNOFF COEFFICIENTS. Tables Detail A and B for using the rational formula.

DETAIL A: RUNOFF COEFFICIENTS (C), RATIONAL FORMULA

Land Use	Percent Impervious Area	Design Storm 24-Hour Event	Hydrologic Soil Group											
			A			B			C			D		
			Slope Range (%)			Slope Range (%)			Slope Range (%)			Slope Range (%)		
			0 - 2	2 - 6	> 6	0 - 2	2 - 6	> 6	0 - 2	2 - 6	> 6	0 - 2	2 - 6	> 6
Industrial	90	2 - and 10-year 25-, 50-, and 100-year	0.67 0.85	0.58 0.85	0.68 0.86	0.68 0.85	0.68 0.86	0.69 0.86	0.68 0.86	0.69 0.86	0.69 0.87	0.69 0.86	0.69 0.86	0.70 0.88
Commercial	95	2 - and 10-year 25-, 50-, and 100-year	0.71 0.88	0.71 0.89	0.72 0.89	0.71 0.89	0.72 0.89	0.72 0.89	0.72 0.89	0.72 0.89	0.72 0.89	0.72 0.89	0.72 0.89	0.72 0.90
Residential: High-density (>6 units/acre)	60	2 - and 10-year 25-, 50-, and 100-year	0.47 0.58	0.49 0.60	0.50 0.61	0.48 0.59	0.50 0.61	0.52 0.64	0.49 0.60	0.51 0.62	0.54 0.66	0.51 0.62	0.53 0.66	0.56 0.69
Medium-density (2-6 units/acre)	30	2 - and 10-year 25-, 50-, and 100-year	0.25 0.33	0.28 0.37	0.31 0.40	0.27 0.35	0.30 0.39	0.35 0.44	0.30 0.38	0.33 0.42	0.38 0.49	0.33 0.41	0.36 0.45	0.42 0.54
Low-density (0.7-2 units/acre)	15	2 - and 10-year 25-, 50-, and 100-year	0.14 0.22	0.19 0.26	0.22 0.29	0.17 0.24	0.21 0.28	0.26 0.34	0.20 0.28	0.25 0.32	0.31 0.40	0.24 0.31	0.28 0.35	0.35 0.46
Agriculture	5	2 - and 10-year 25-, 50-, and 100-year	0.08 0.14	0.13 0.18	0.16 0.22	0.11 0.16	0.15 0.21	0.21 0.28	0.14 0.20	0.19 0.25	0.26 0.34	0.18 0.24	0.23 0.29	0.31 0.41
Open Space	2	2 - and 10-year 25-, 50-, and 100-year	0.05 0.11	0.10 0.16	0.14 0.20	0.08 0.14	0.13 0.19	0.19 0.26	0.12 0.18	0.17 0.23	0.24 0.32	0.16 0.22	0.21 0.27	0.28 0.39
Freeways and Expressways	70	2 - and 10-year 25-, 50-, and 100-year	0.57 0.70	0.59 0.71	0.60 0.72	0.58 0.71	0.60 0.72	0.61 0.74	0.59 0.72	0.61 0.72	0.63 0.73	0.60 0.76	0.62 0.75	0.64 0.78

Source: Wisconsin department of transportation, (WDOT), Facilities Development Manual (July 2, 1979), Procedure 13-10-5.

DETAIL B: RUNOFF COEFFICIENTS (C), FOR SPECIFIC LAND USE

Land Use	Design Storm 24-Hour Event	Hydrologic Soil Group											
		A			B			C			D		
		Slope Range (%)			Slope Range (%)			Slope Range (%)			Slope Range (%)		
		0 - 2	2 - 6	> 6	0 - 2	2 - 6	> 6	0 - 2	2 - 6	> 6	0 - 2	2 - 6	> 6
Row Crops	2 - and 10-year 25-, 50-, and 100-year	0.08 0.22	0.16 0.30	0.22 0.38	0.12 0.16	0.20 0.34	0.27 0.44	0.15 0.30	0.24 0.37	0.33 0.50	0.19 0.34	0.28 0.41	0.38 0.56
Median Strip, turf	2 - and 10-year 25-, 50-, and 100-year	0.19 0.24	0.20 0.26	0.24 0.30	0.19 0.25	0.22 0.28	0.26 0.33	0.20 0.26	0.23 0.30	0.30 0.37	0.20 0.27	0.25 0.32	0.30 0.40
Slide Slope, turf	2 - and 10-year 25-, 50-, and 100-year	-- --	-- --	0.25 0.32	-- --	-- --	0.27 0.34	-- --	-- --	0.28 0.36	-- --	-- --	0.30 0.38
Pavement:													
Asphalt		0.70 - 0.95											
Brick		0.70 - 0.80											
Concrete		0.80 - 0.95											
Drives and Walks		0.75 - 0.85											
Roofs		0.75 - 0.95											
Gravel Roads Shoulders		0.40 - 0.60											

Source: Wisconsin department of transportation, (DOT), Facilities Development Manual (July 2, 1979), Procedure 13-10-5.

Note: The lower "C" values in each range should be used with the relatively low intensities associated with 2- to 10-year design recurrence intervals whereas the higher "C" values should be used for intensities associated with the longer 25- to 100-year design recurrence intervals.

Note: In parking lot runoff, visible sheen has been accepted as having an oil concentration of 15 mg/L.

A-82.36 (4)-3. OTHER METHODS OR MODELS. A model that calculates peak flow such as TR-55, P8 or an equivalent methodology may be used.

Information on how to access P8 is available at the department of natural resources webpage: <http://www.dnr.state.wi.us/org/water/wm/nps/slammm.html> or contact the stormwater coordinator in the runoff management section of the bureau of watershed management at the department of natural resources at phone 608-267-7694.

A simplified TR-55 approach, TR-55 (210-vf-TR-55, second edition, June 1986), may be obtained by accessing the USDA NRCS webpage: <http://www.wcc.nrcs.usda.gov/water/quality/common/tr55/tr55.html>.

A-82.36 (6)-1. THE FORMULA FOR SOLVING FOR DIAMETER, D FOR ROOF CONDUCTORS.

$$D=1.128\sqrt{\frac{A}{X}}$$

Where, A = the area of the roof in square feet.

X = one of the following:

300 square feet per square inch for a roof covered with gravel or slag and with a pitch not exceeding ¼ inch per foot.

250 square feet per square inch for a roof covered with gravel or slag and with a pitch of greater than ¼ inch per foot.

200 square feet per square inch for a roof with a metal, tile, brick or slate covering and with any pitch.

A-82.36 (9) (b) AREA DRAIN INLETS.

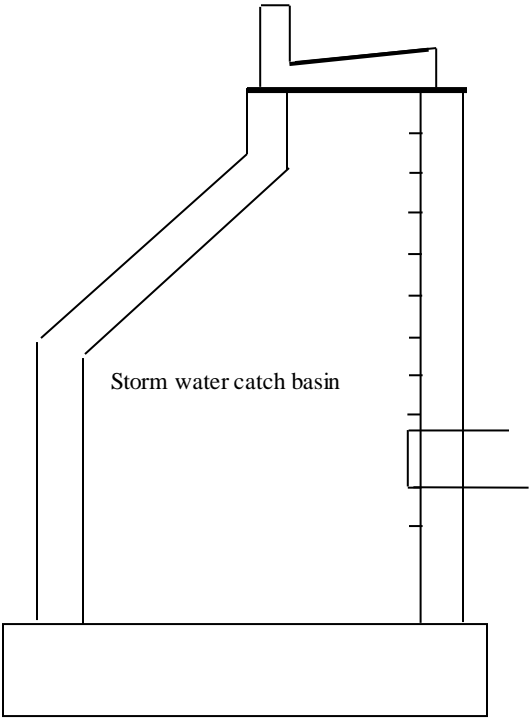
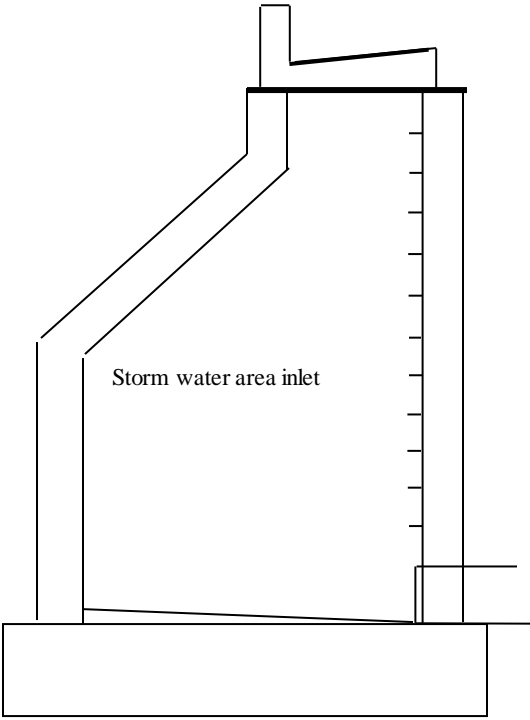

A-82.36 (9) (b) 3. INLET GRATES.

GRATES FOR HORIZONTAL PIPING

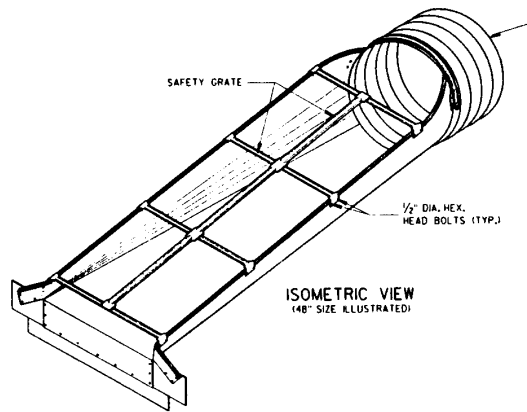

GRATES FOR VERTICAL PIPING

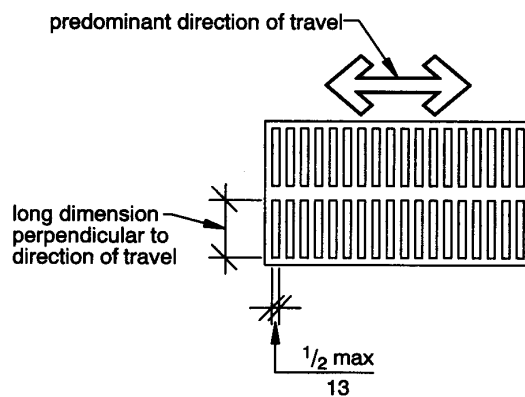

FORMULA TO CALCULATE CAPACITY, IN CUBIC FEET PER SECOND:

$$Q = 2/3 A C (2gh)^{1/2}$$

- Where: Q = the capacity of the inlet, cfs
 2/3 = a factor to correct for assumed blockage of 1/3 of the inlet's net open area
 A = the net open area of the inlet, sq. ft
 C = an orifice coefficient, usually taken as 0.60
 g = a constant, 32.2 ft/sec/sec
 h = the head, in feet on the inlet, or the depth of water on top of the inlet, usually not more than two or three inches.

A-82.365 (1) CLASS V INJECTION WELLS. An injection well is described as being any well, drilled or dug hole, used to inject fluids into the subsoil; a stormwater collection well may be a class V injection well.

Federal regulations (40 CFR 144.26) require that all injection wells be reported to the state underground injection control (UIC) program authority for the purpose of developing a state inventory of injection practices. In Wisconsin, the department of natural resources, bureau of drinking water and groundwater, maintains this inventory and registration program, form 3300-253. For further information, refer to www.dnr.state.wi.us/.

A-82.37 (3) CAMPSITE RECEPTORS AND WATER SUPPLY

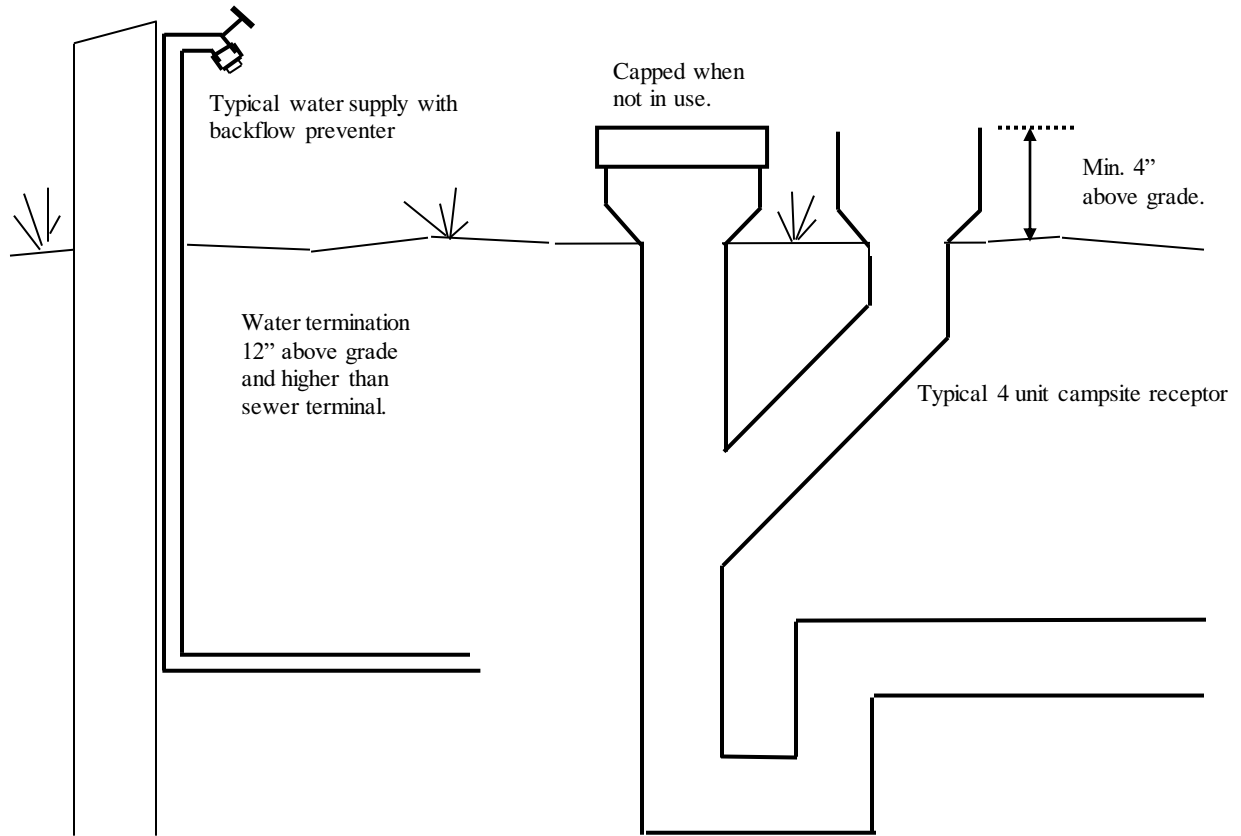

A-82.40 (4) CONTROL VALVES.

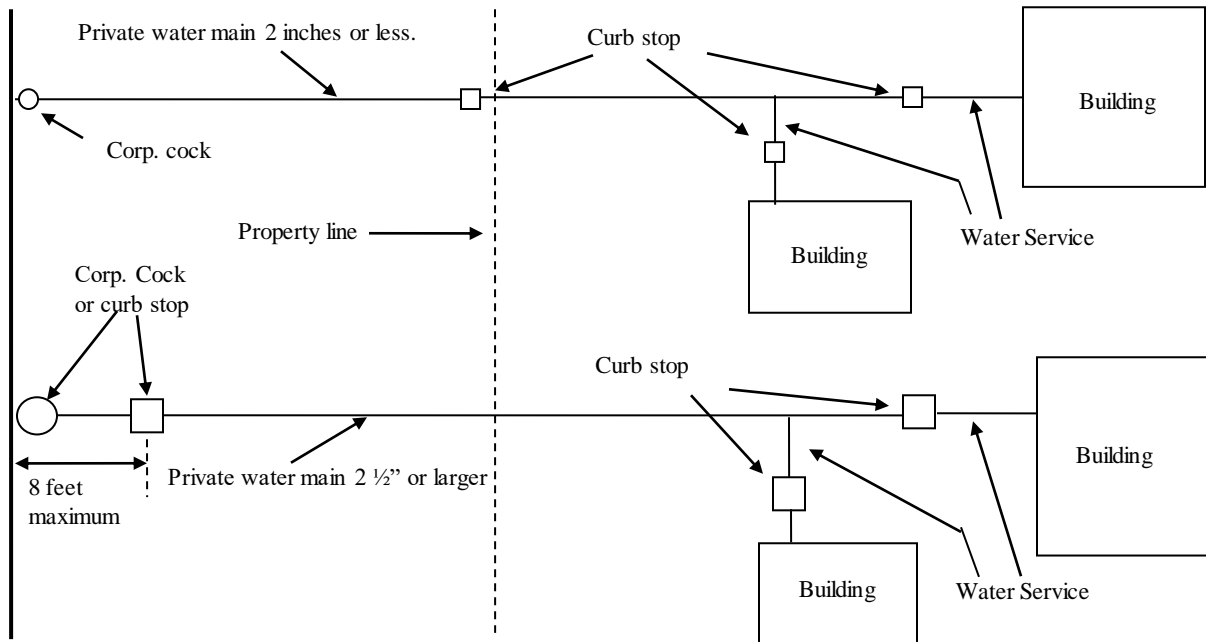

A-82.40 (5) PIPING INSULATION. The following is a reprint of s. Comm 63.1029(1) and (2) and Table 63.1029.

Comm 63.1029 Insulation, materials and construction. (1) GENERAL. Insulation required by subs. (2) and (3) shall be suitably protected from damage. Insulation shall be installed in accordance with practices acceptable to the department. The department accepts MICA Commercial and Industrial Insulation Standards as an insulation installation practice.

(2) PIPING INSULATION. Except as provided in pars. (a) to (c), recirculating plumbing system piping, plumbing piping in the first 8 feet from storage tanks for noncirculating systems, any piping served by a self-regulating electric heating cable, HVAC system piping, and related HVAC fluid conveying conduit, such as heat exchanger bodies, shall be thermally insulated in accordance with Table 63.1029 or equivalent. The following piping or conduit is exempted from this subsection:

- (a) Factory-installed piping or conduit within HVAC equipment tested and rated in accordance with s. Comm 63.1020;
- (b) Piping or conduit for which no insulation is specified in Table 63.1029.
- (c) Where it can be shown that the heat gain or heat loss to or from piping or conduit without insulation will not increase building energy use.

**Table 63.1029
Plumbing and HVAC Piping Minimum Insulation (R-value)**

Fluid Design Operating Temp. Range, °F	Insulation Conductivity ^a		Nominal Pipe Diameter					
	Conductivity Range Btr in./- (h ft ² ·°F)	Mean Rating Temp. °F	Runouts ^b up to 2 inches	1 inch and less	1-1/4 to 2 inches	2-1/2 to 4 inches	5 & 6 inches	8 inches & up
Heating systems (Steam, Steam Condensate, and Hot Water)								
Above 350	0.32-0.34	250	R-4.4	R-4.4	R-7.4	R-8.8	R-10.3	R-10.3
251-350	0.29-0.31	200	R-4.8	R-4.8	R-8.1	R-8.1	R-11.3	R-11.3
201-250	0.27-0.30	150	R-3.3	R-3.3	R-5.0	R-6.7	R-6.7	R-11.7
141-200	0.25-0.29	125	R-1.8	R-1.8	R-5.2	R-5.2	R-5.2	R-5.2
105-140	0.24-0.28	100	R-1.8	R-1.8	R-3.6	R-3.6	R-3.6	R-5.4
Domestic and Service Hot Water systems^c								
105 and greater	0.24-0.28	100	R-1.8	R-3.6	R-3.6	R-5.4	R-5.4	R-5.4
Cooling systems (Chilled water, brine, and refrigerant)^d								
40-55	0.23-0.27	75	R-1.9	R-1.9	R-2.8	R-3.7	R-3.7	R-3.7
Below 40	0.23-0.27	75	R-3.7	R-3.7	R-5.6	R-5.6	R-5.6	R-5.6

^a For insulation outside the state conductivity range, the minimum thickness (T) shall be determined as follows: $T = PR [(1+t/PR)^{K/k} - 1]$, where T = minimum insulation thickness for material with conductivity K, in.; PR = actual outside radius of pipe, in.; t = insulation thickness, in.; K = conductivity of alternate material at mean rating temperature indicated for eh application fluid temperature; and k = the lower value of the conductivity range listed for eh applicable fluid temperature.

^b Runouts to individual terminal units not exceeding 12 ft. in length.

^c Applies to recirculating sections of service or domestic hot water systems and first 8 ft. from storage tank for nonrecirculating systems.

^d The required minimum thickness does not consider water vapor transmission and condensation.

A-82.40 (7) (a) METHODOLOGY.

Where equipment such as an instantaneous or tankless water heater, water treatment device, water meter, and backflow preventer is provided in the design, the friction loss in such equipment, corresponding to the GPM demand, should be determined from the manufacturer or other reliable source.

Where a direct fired pressurized tank type water heater is provided in the design, the friction loss for such equipment can be assumed as part of the pressure losses due to flow through piping, fittings, valves and other plumbing appurtenances when the developed length of piping is multiplied by 1.5.

The pressure losses due to flow friction through displacement type cold-water meters may be calculated from Graph A-82.40 (7)-1.

Graph A-82.40 (7) - 1
PRESSURE LOSS IN COLD-WATER METERS, DISPLACEMENT TYPE

MAXIMUM CAPACITY AND PRESSURE LOSS
AS PER AWWA 6700-64

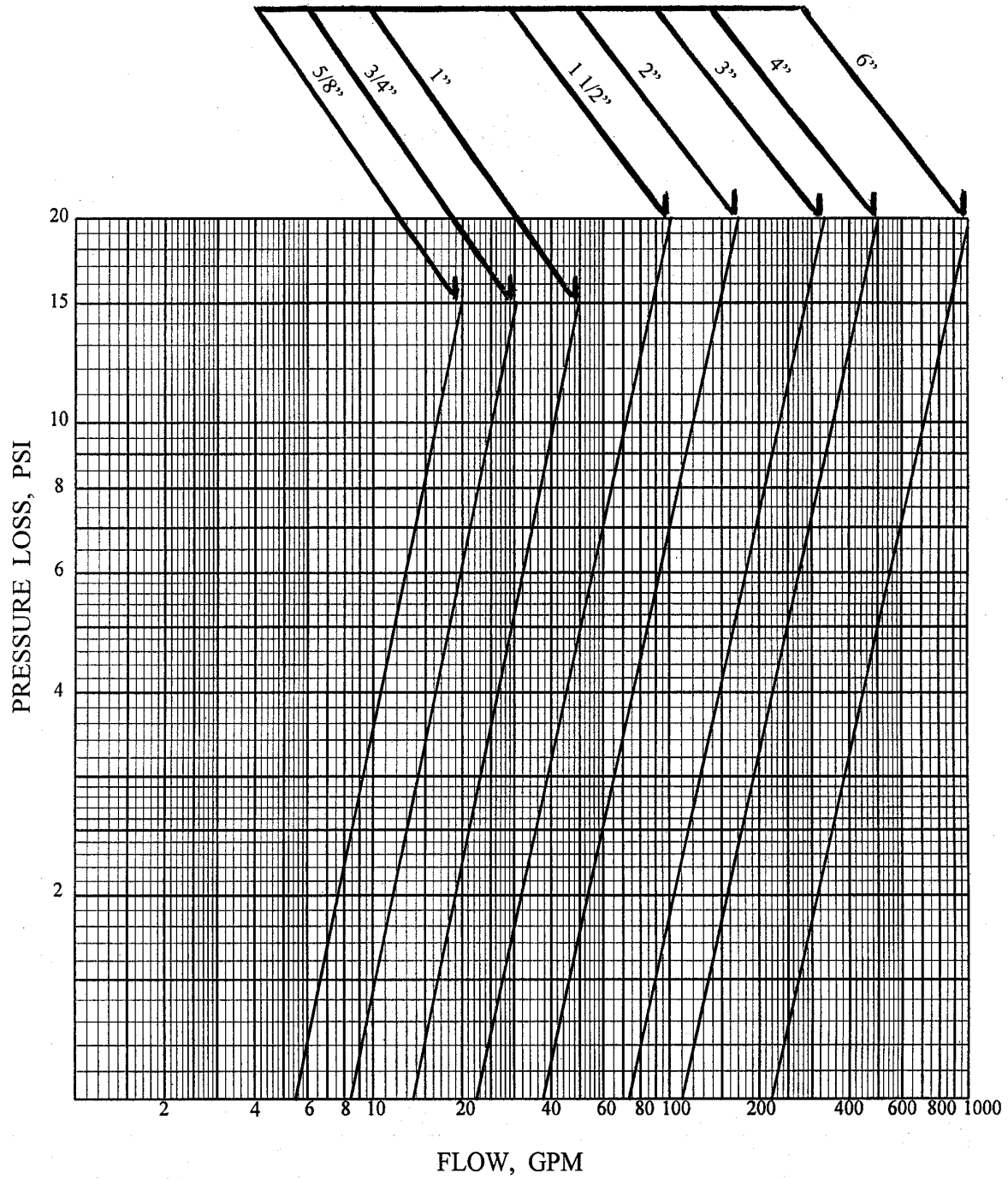

Graph A-82.40 (7)-2
 Pressure losses due to flow friction
 Material: Copper Tube-Type K, ASTM B88; (C = 150)

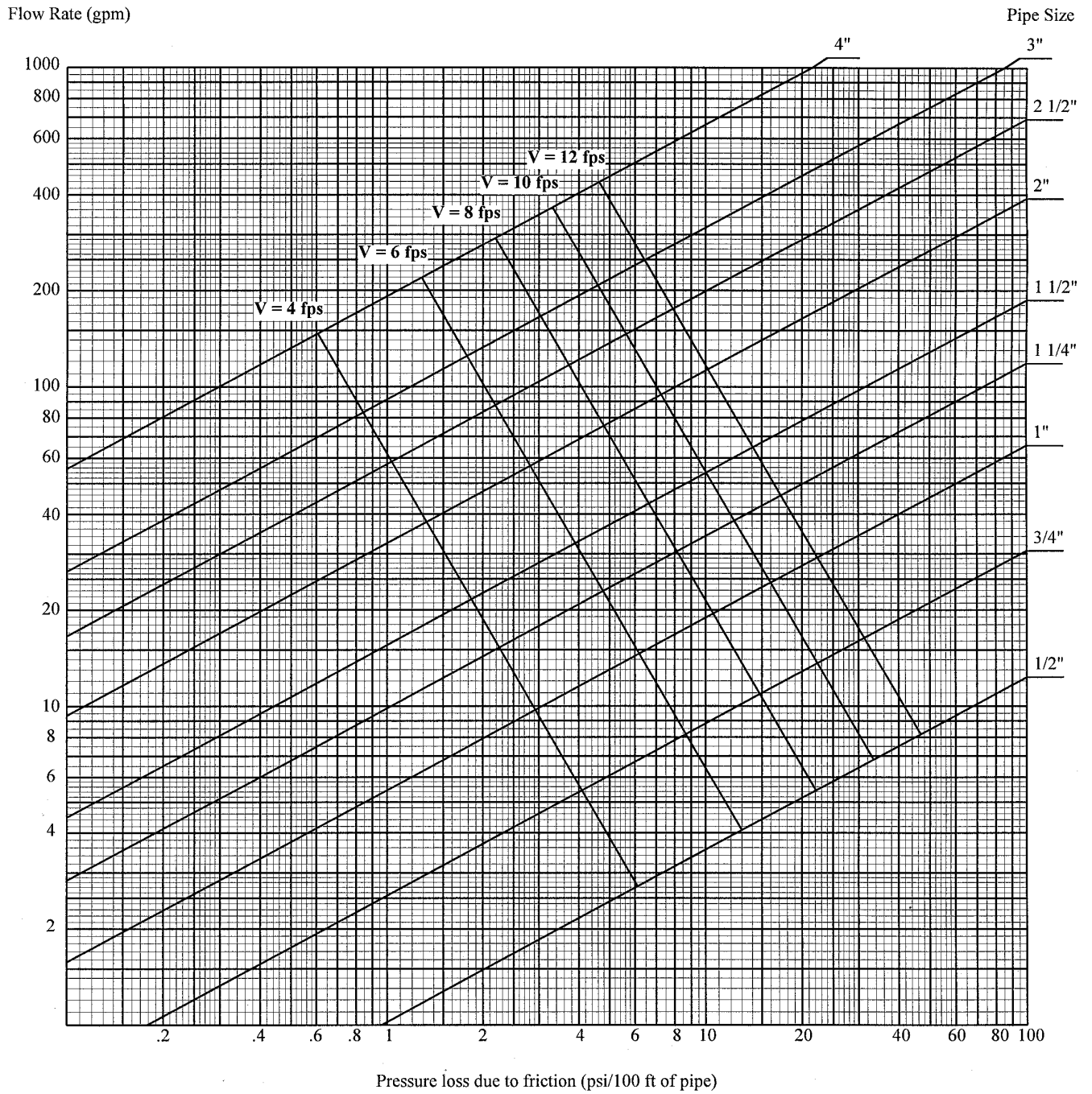

Graph A-82.40 (7)-3
 Pressure losses due to flow friction
 Material: Copper Tube-Type L, ASTM B88; (C = 150)

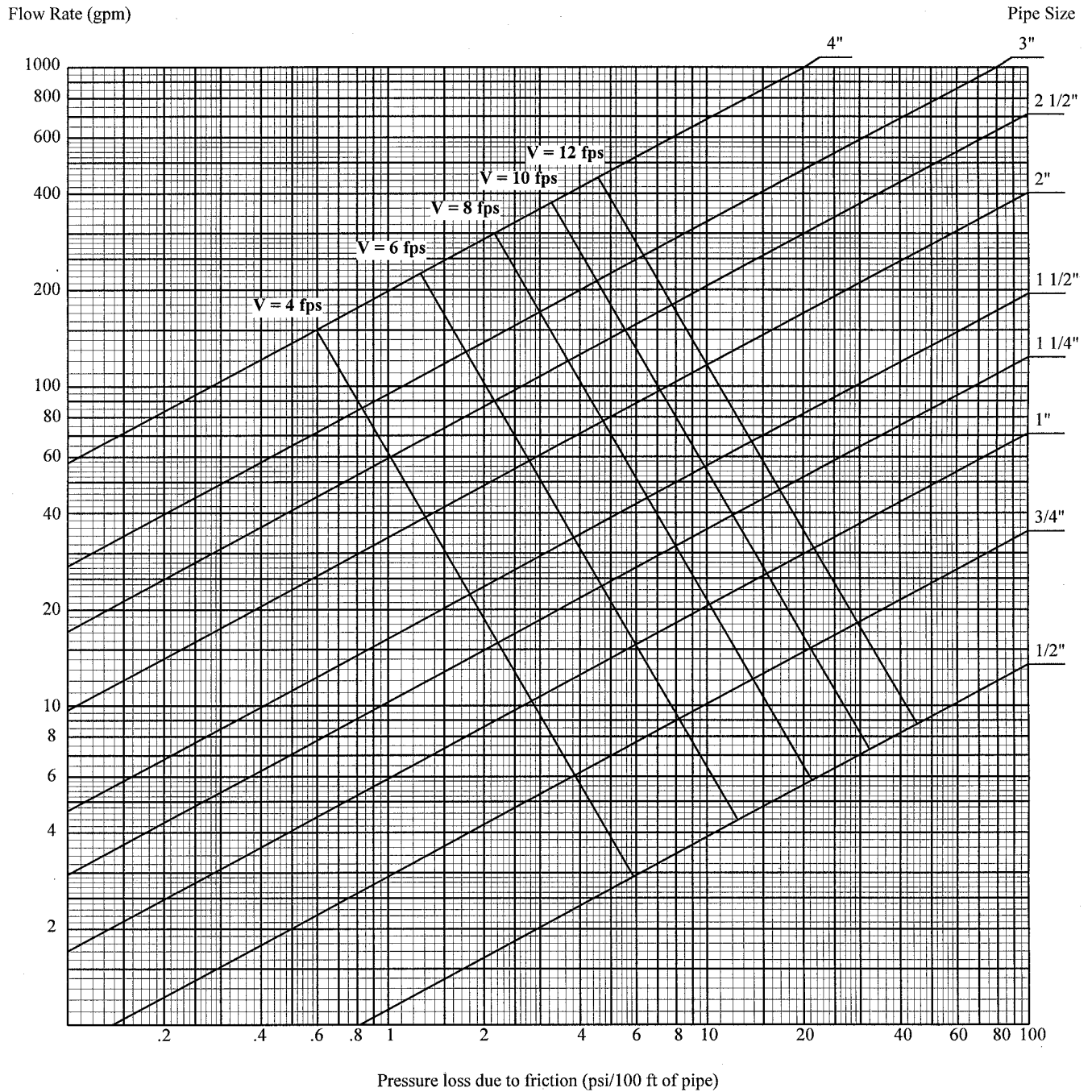

Graph A-82.40 (7)-4

Pressure losses due to flow friction

Material: Galvanized Steel Pipe-Schedule 40, ASTM A53, ASTM A120; (C = 125)

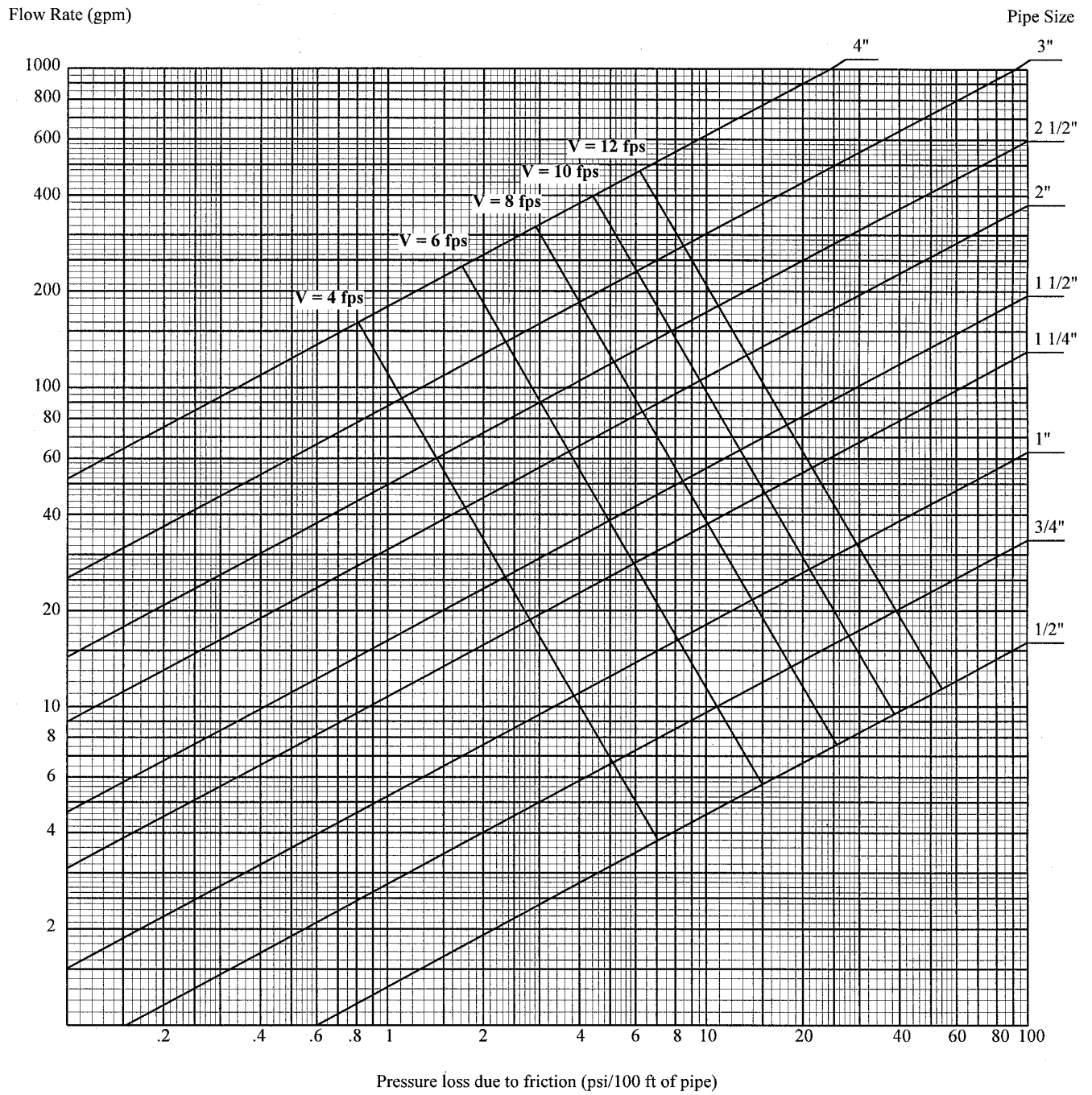

Graph A-82.40 (7)-5

Pressure losses due to flow friction
Material: Polybutylene Tubing, ASTM D3309; or
CPVC Tubing, ASTM D2846; (C = 150)

Flow Rate (gpm)

Pipe Size

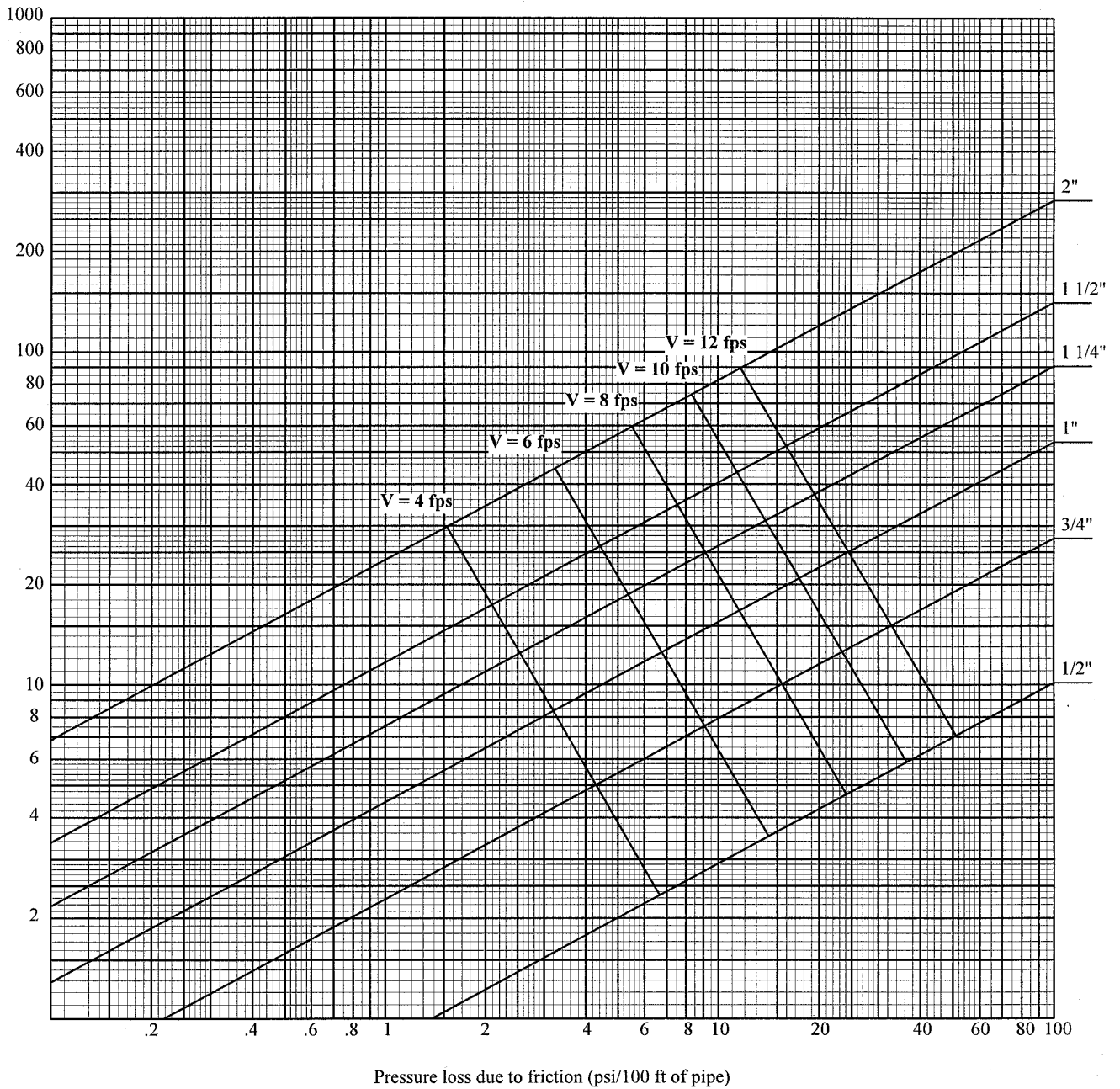

Graph A-82.40 (7)-6
 Pressure losses due to flow friction
 Material: Crosslinked Polyethylene (PEX) Tubing, ASTM F876; (C = 150)

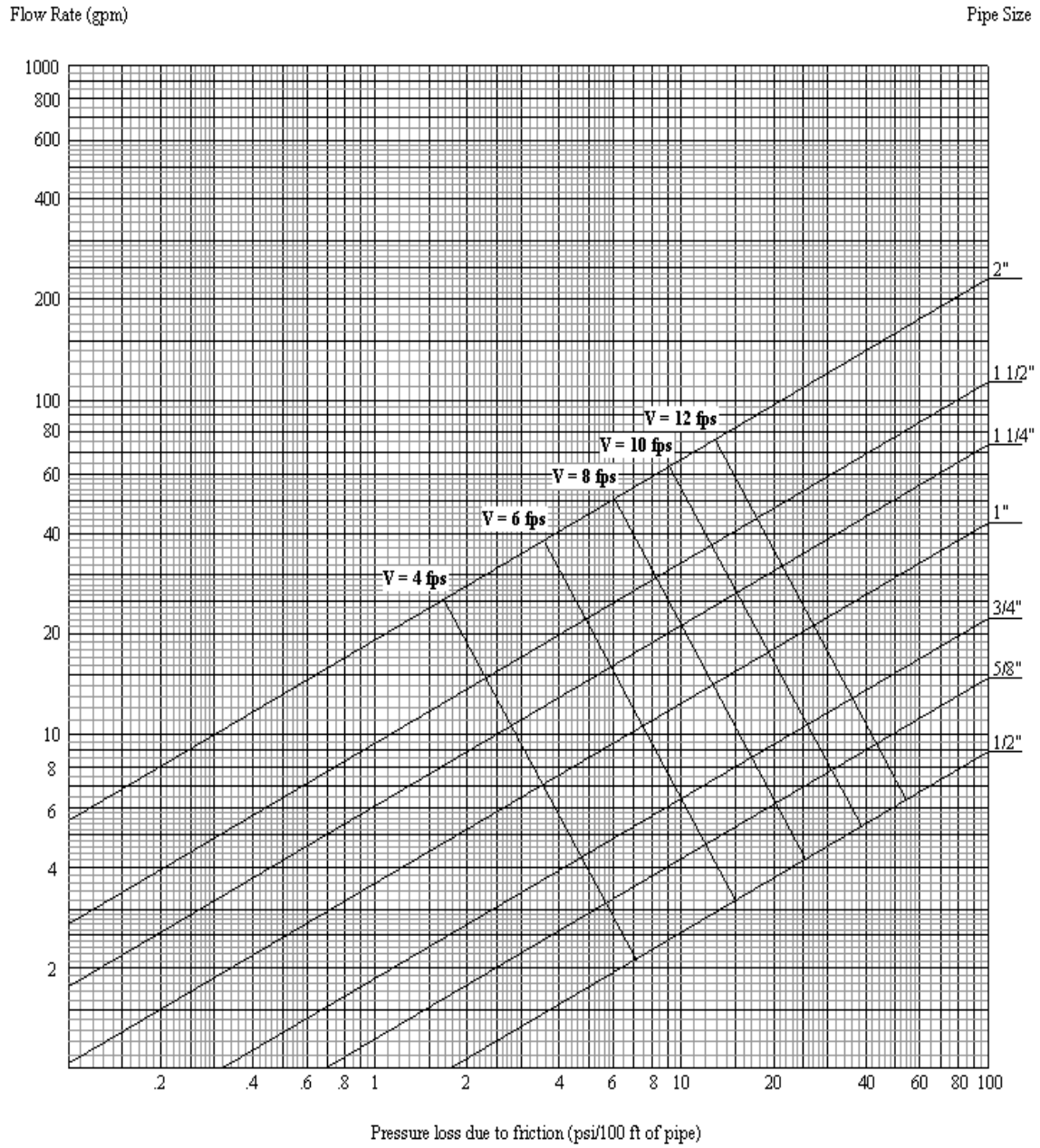

Graph A-82.40 (7)-7

Pressure losses due to flow friction

Material: Polyethylene Tubing, Copper Tube Size, ASTM D2737; (C = 150)

Flow Rate (gpm)

Pipe Size

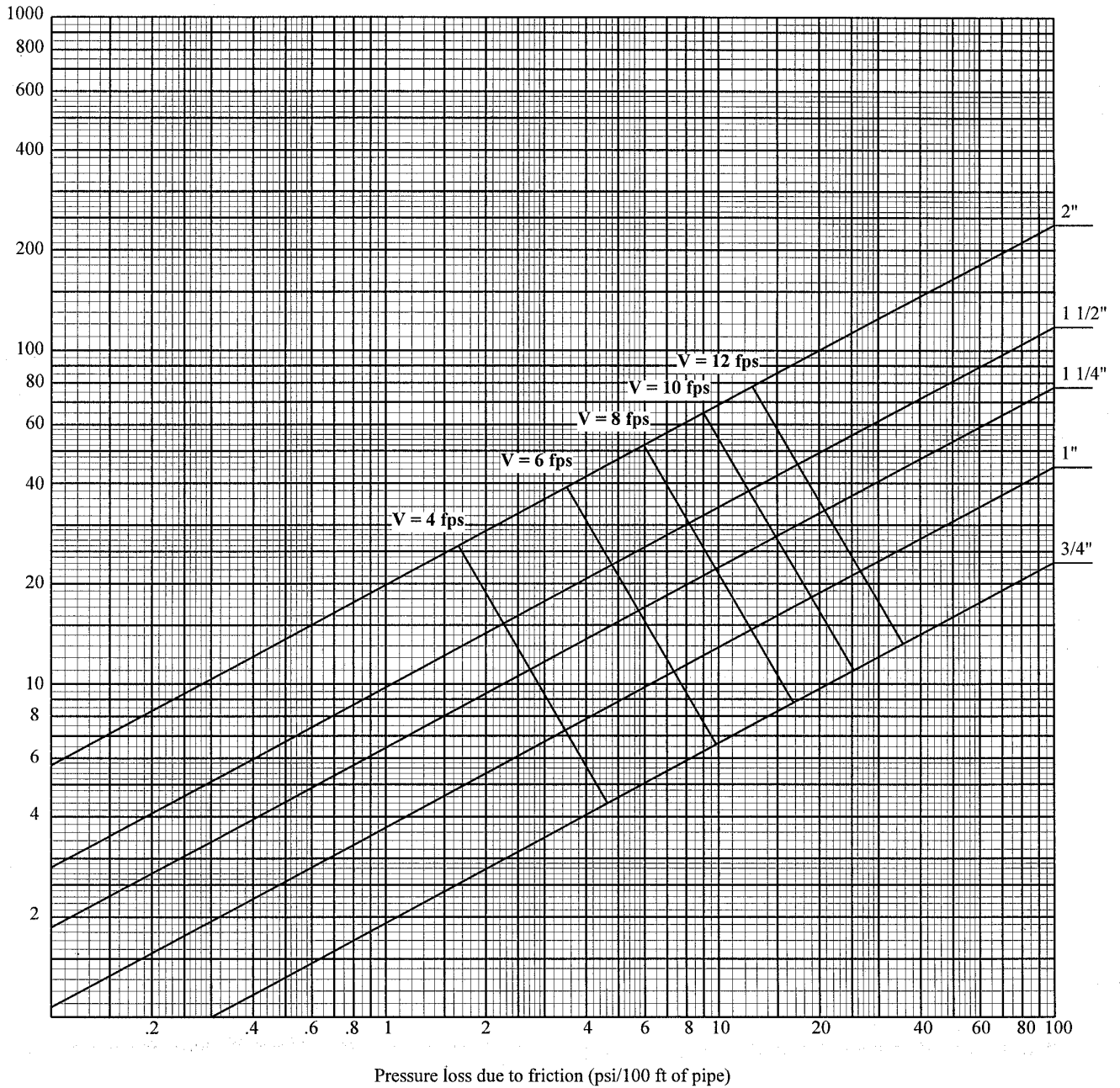

Graph A-82.40 (7)-8

Pressure losses due to flow friction

Material: ABS Pipe-Schedule 40; ASTM D1527; or

CPVC Pipe-Schedule 40; ASTM F441; or

PE Pipe-Schedule 40; ASTM D2104; ASTM D2447; or

PVC Pipe-Schedule 40; ASTM D1785; ASTM D2672; (C = 150)

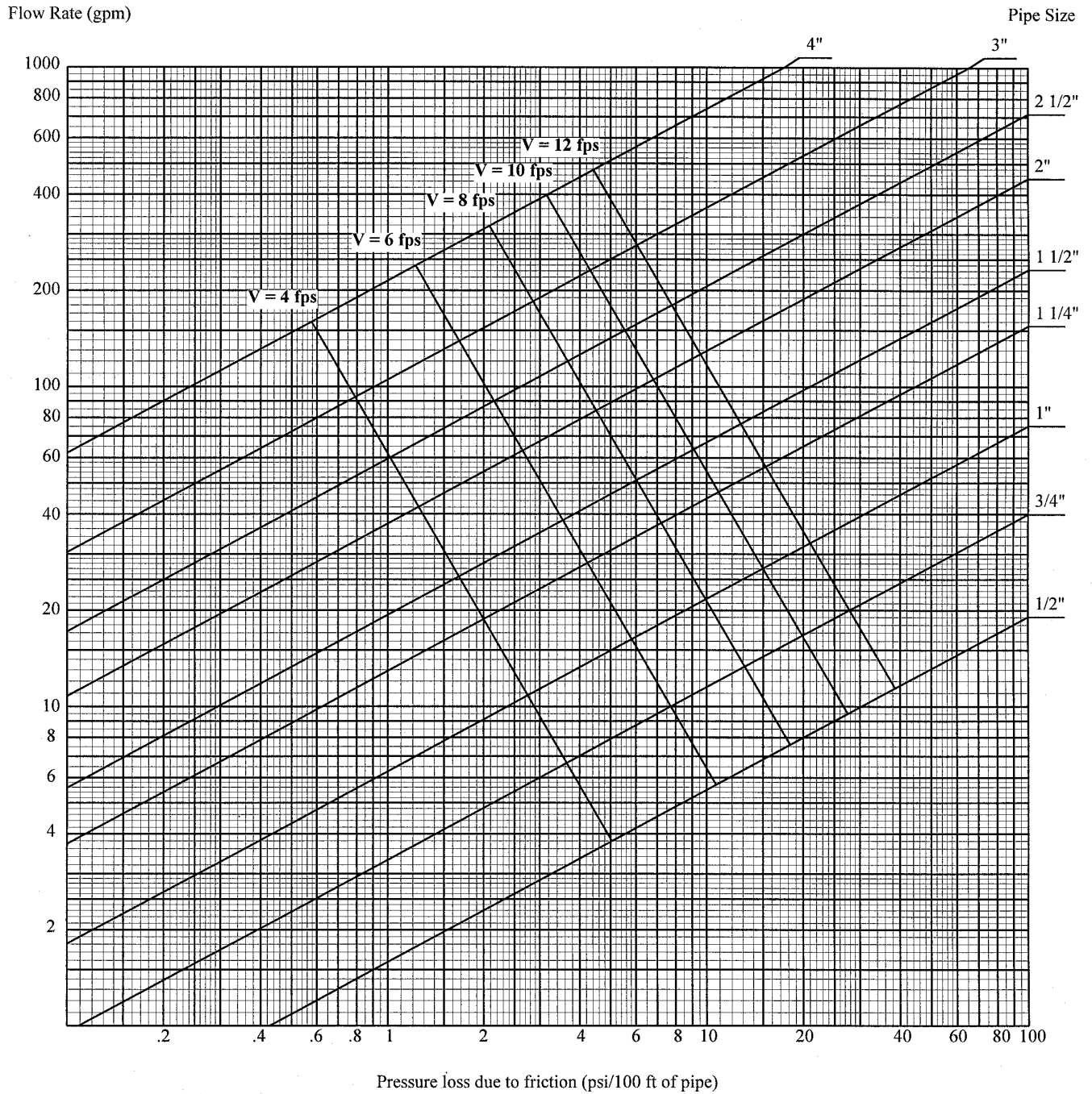

Graph A-82.40 (7)-9
 Pressure losses due to flow friction
 Material: Copper Tube-Type M, ASTM B88; (C = 150)

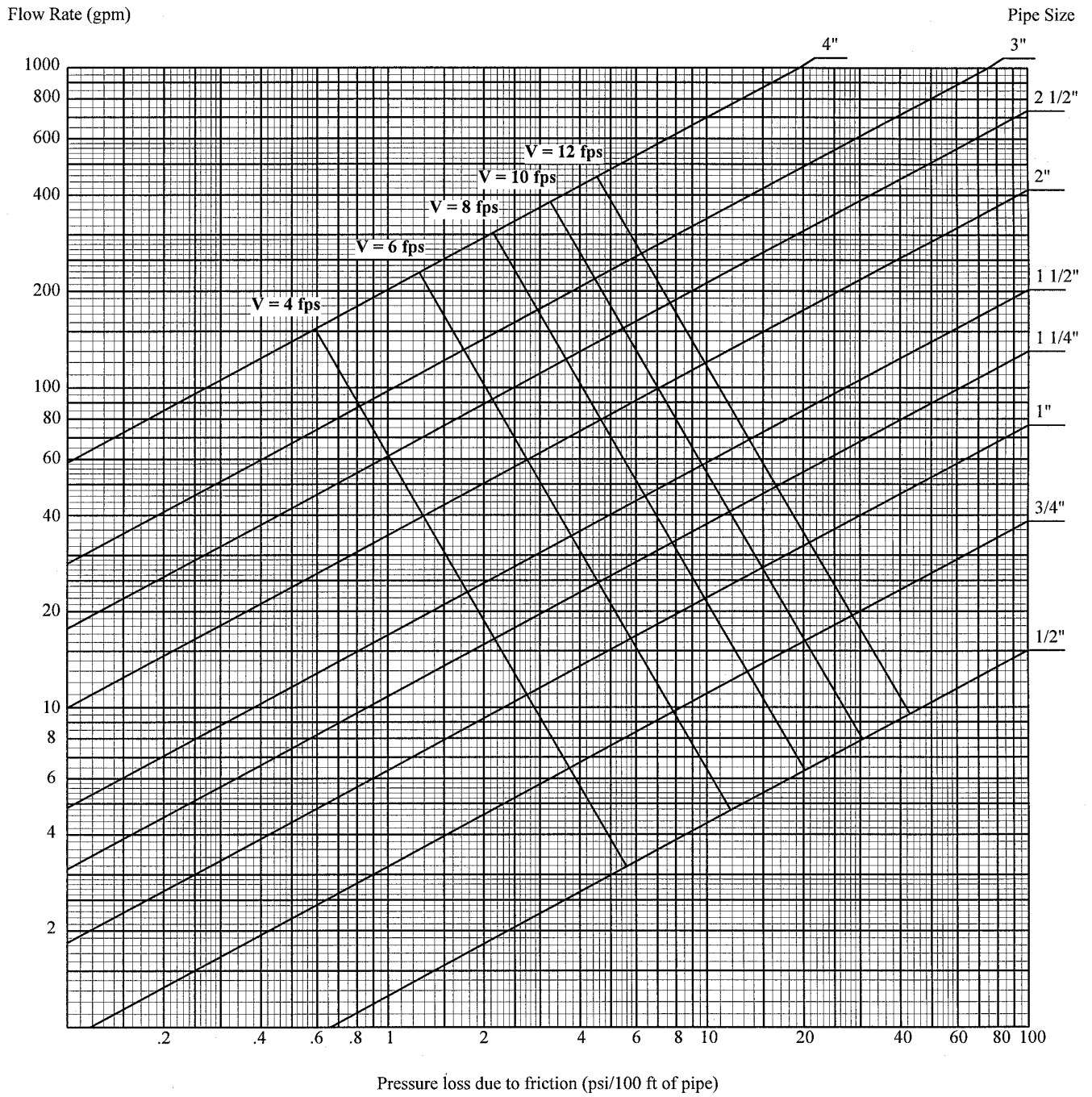

Graph A-82.40 (7)-10

Pressure losses due to flow friction

Material: Polyethylene Aluminum Polyethylene Tubing (PexAlPex), ASTM F1281; (C = 150)

Flow Rate (gpm)

Pipe Size

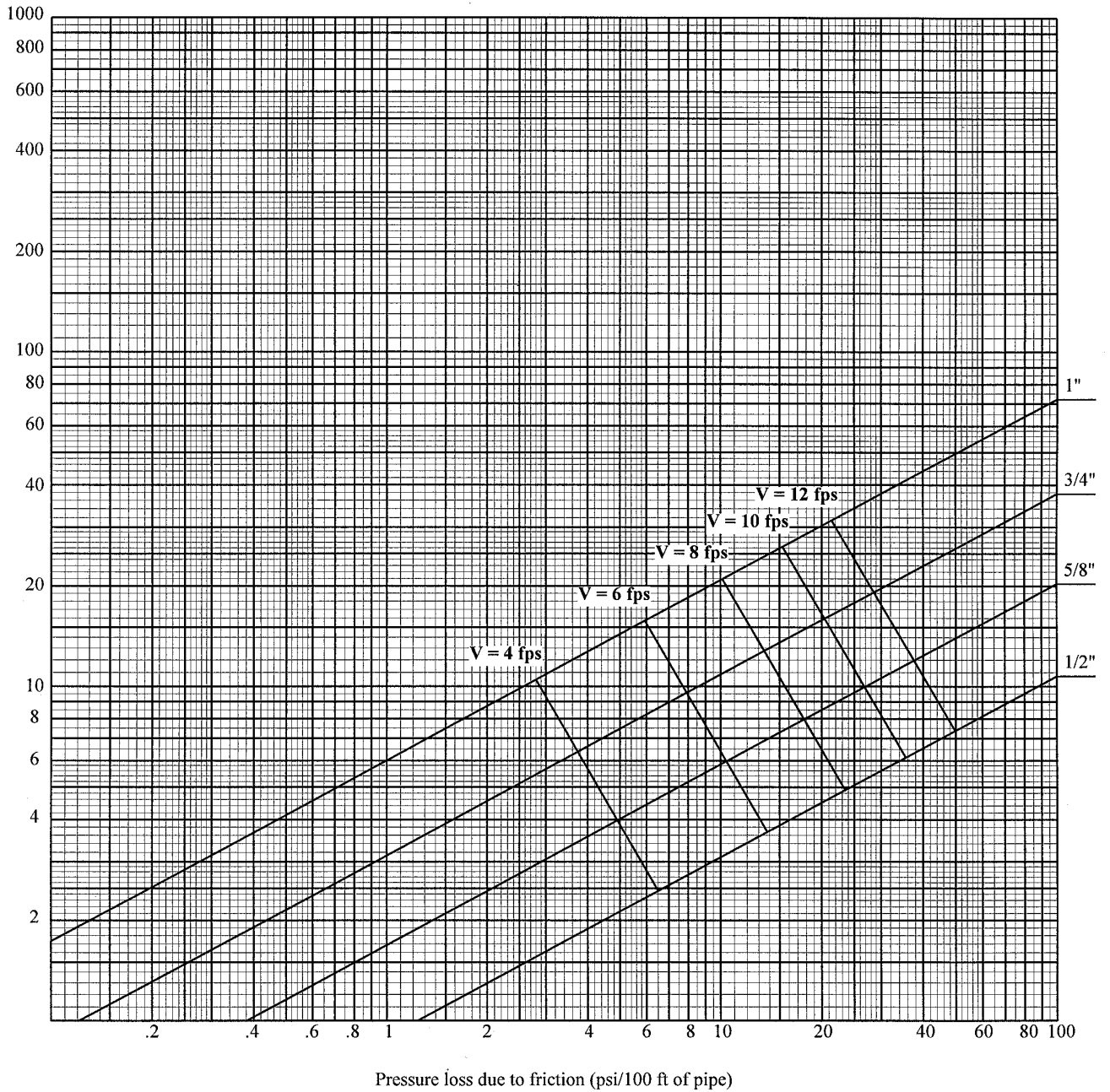

Graph A-82.40 (7)-11
 Pressure losses due to flow friction
 Material: CPVC Tubing, SDR 13.5; ASTM F442; (C = 150)

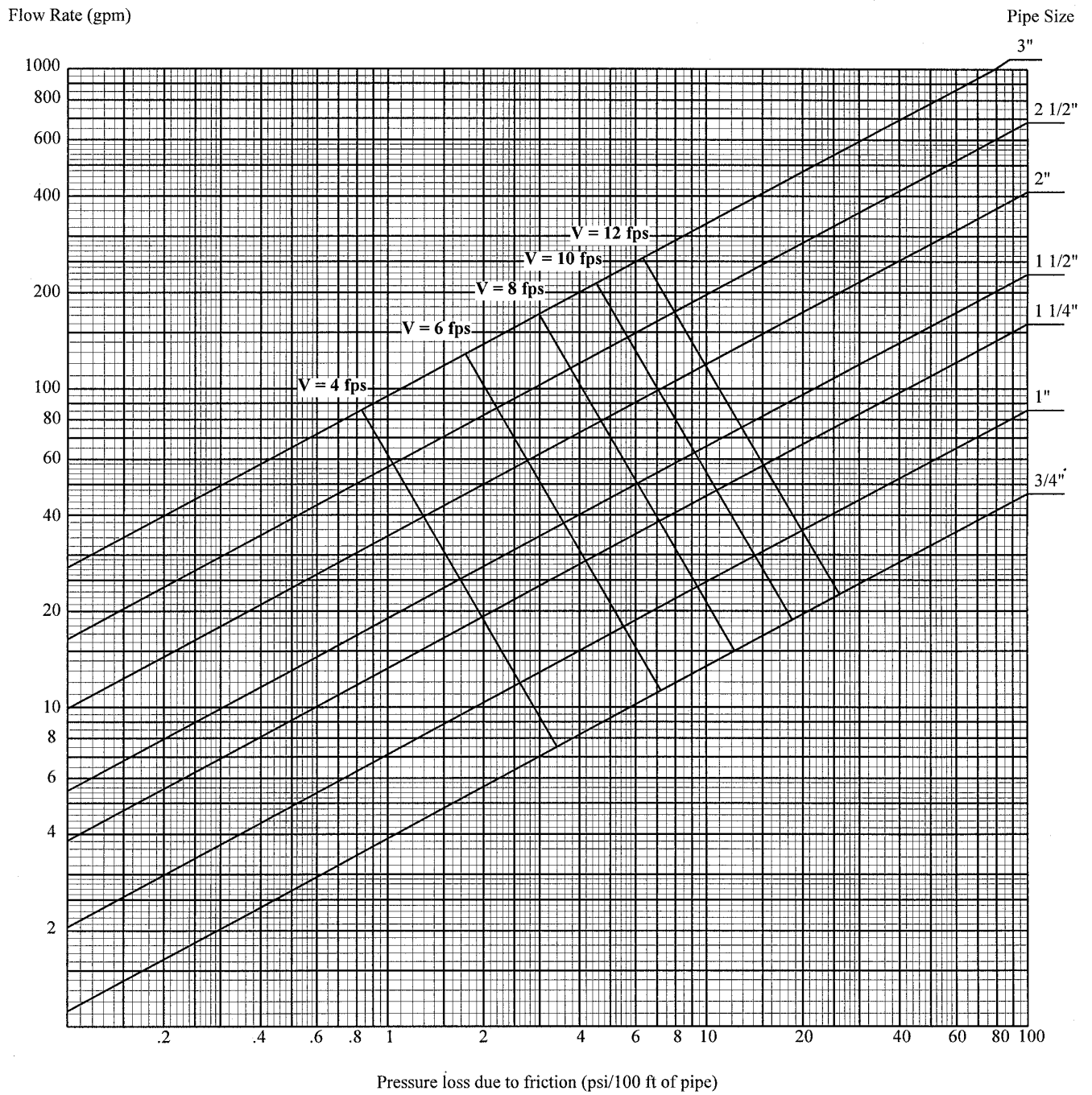

A-82.41(5)(a) AIR GAP. An air gap for cross connection control for water supply systems conforming to ASME 112.1.2.

Section Comm 81.01 (5) reads: “Air Gap”, water supply system, means the unobstructed vertical distance through the free atmosphere between the lowest opening from any pipe or faucet supplying water to a tank or plumbing fixture and the flood level rim or spill level of the receptacle.’

A pipe/spout which terminates with its outlet above the flood level rim of a receptacle/fixture;

1. Shall terminate a minimum of one inch above the flood level rim of the receptacle/fixture, or
2. Shall terminate a minimum distance of two times the diameter of the effective opening from the end of the pipe/spout to the flood level rim of the receptacle/fixture.

Note: In any case, REGARDLESS of whether the end of the pipe/spout is cut square or at an angle, the air gap is the distance between the lowest end of the pipe/spout and the flood level rim of the receptacle/fixture.

The following water supply air gap, although the least desirable, is acceptable to the ASME 112.1.2 standard.

A pipe/spout(s) which terminate with its outlet(s) completely below the flood level rim of a receptacle/fixture:

1. Must have an opening in the receptacle/fixture which discharges to the atmosphere through an air gap,
2. This air gap must be located as close as possible to the receptacle/fixture,
3. The rate of discharge through this opening as compared to the rate of water entering the receptacle/fixture establishes a “spill level”, which is the level at which water entering the receptacle/fixture seeks a balance and does not raise any higher. (a level is established where the flow of water entering equals the flow of water exiting),
4. The distance then, between this established “spill level” and the end of the lowest water supply pipe/spout is the air gap,

5. The minimum air gap (“Y”) is the distance between the supply pipe/spout(s) and the “spill level” established in the receptacle/fixture,

6. The “spill level” shall be a distance no greater than one half of the distance measured as “Y” $(1/2 \text{ “Y”})$ above the discharge opening in the receptacle/fixture, therefore, the air gap between the supply pipe/spout(s) and the highest portion of the opening which discharges to the atmosphere shall be a distance no greater than one and one half “Y” $(1-1/2 \text{ “Y”})$.

Note: In any case, REGARDLESS of whether the end of the pipe/spout(s) is cut square or at an angle, the air gap is the distance between the lowest end of the pipe/spout(s) and the “spill level” of the receptacle/fixture.

However, the measurement for this air gap could be as much as three times the diameter of the pipe/spout(s) depending upon the number of near walls.

The distance of a near wall is a relationship to the diameter of the pipe/spout(s) and the measurement from the wall to the closest side of the pipe/spout(s),

1. If there is one near wall, and the distance between that near wall and the closest edge of the supply pipe/spout(s) is greater than 3 times the diameter of the supply pipe/spout(s), then the minimum air gap is two times the diameter of the supply pipe/spout(s),
2. If there is one near wall, and the distance to the closest edge of the supply pipe/spout(s) is less than three times the diameter of the pipe/spout(s), then the minimum air gap is three times the diameter of the supply pipe/spout(s),
3. If there are two near walls, and the distance between the near wall(s) and closest edge of the supply pipe/spout(s) is greater than four times the diameter of the supply pipe/spout(s), then the minimum air gap is two times the diameter of the supply pipe/spout(s),
4. If there are two near walls, and the distance to the closest edge of the supply pipe/spout(s) is less than four times the diameter of the supply pipe/spout(s), then the minimum air gap is three times the diameter of the supply pipe/spout(s).

It has been determined that near walls of more than two generally have little effect for the need to increase the air gap to more than three times the diameter of the supply pipe/spout(s).

Note: See the following sketches as examples of an air gap with pipe/spouts terminating above the flood level rim of the receptacle/fixture, of an air gap with pipe/spouts terminating below the flood level rim of the receptacle/fixture and of air gap with pipe/spouts when terminating by one near wall.

A-82.41 (5)-1. AIR GAP WITH PIPE/SPOUT(S) ABOVE FLOOD LEVEL RIM OF RECEPTACLE/FIXTURE.

WATER SUPPLY AIR GAP ASME 112.1.2

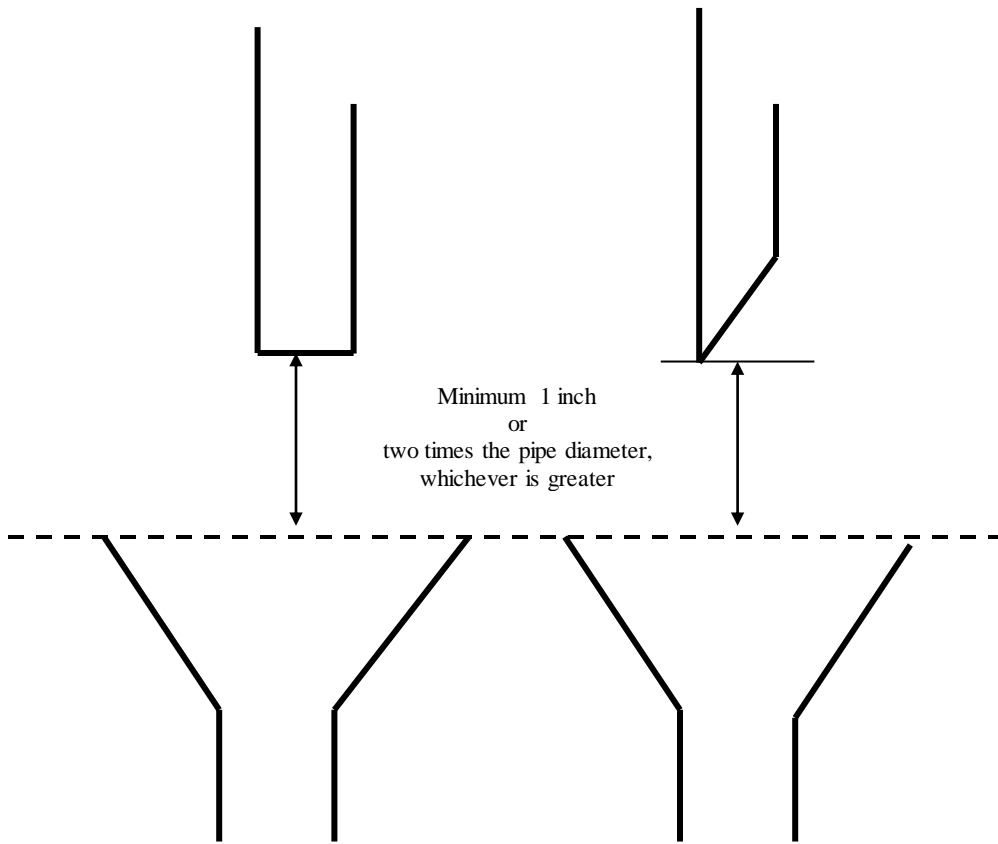

A-82.41(5)-2. AIR GAP WITH PIPE/SPOUT(S) BELOW FLOOD LEVEL RIM OF RECEPTACLE/FIXTURE.

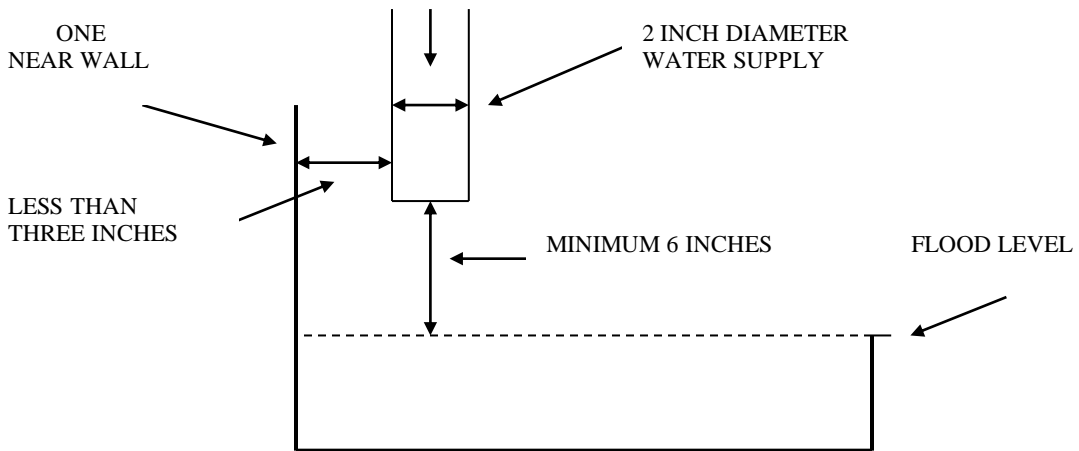
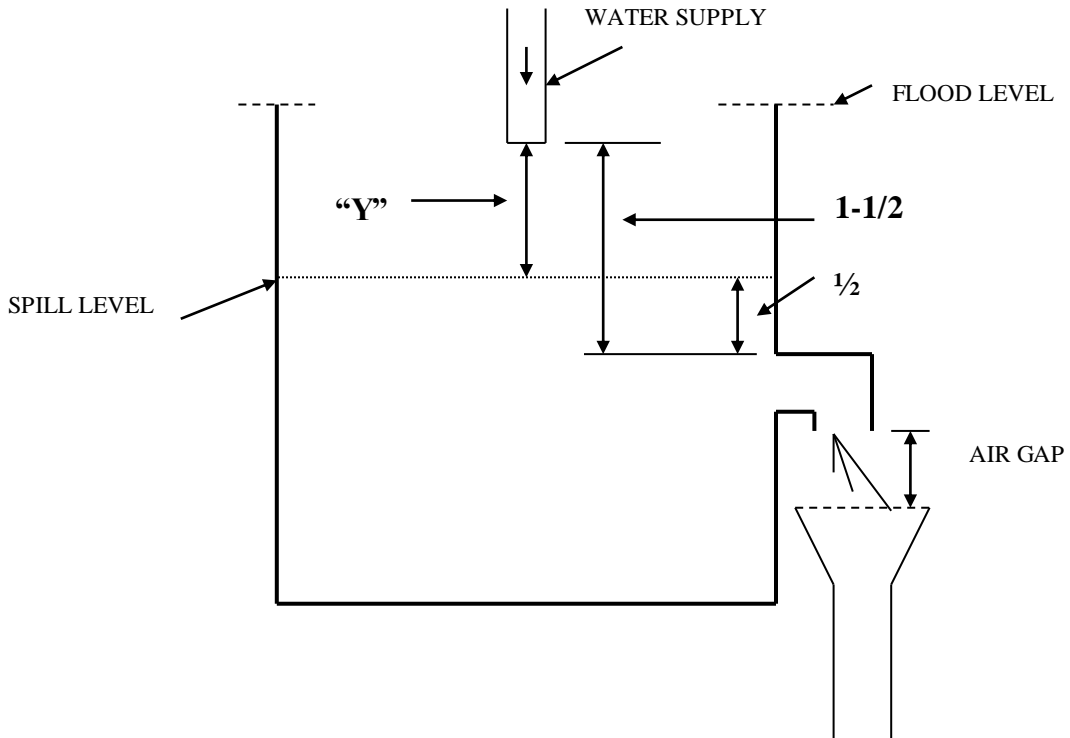

If distance is three times or greater than the diameter of water supply (2 inches) then the air gap is two times the diameter of the water supply, (i.e., $2 \times 2 = 4$ inches)

If the distance is less than three times the diameter of the water supply (2 inches) then the air gap is three times the diameter of the water supply, (i.e., $3 \times 2 = 6$ inches)

A PARTIAL TABLE FOR THE SELECTION OF BACKFLOW PROTECTION *

SITUATION	HAZARD	AIR GAP	ASSE 1001	ASSE 1011	ASSE 1012	ASSE 1013	ASSE 1014	ASSE 1019	ASSE 1020	ASSE 1022	ASSE 1035	ASSE 1052	ASSE 1055	ASSE 1056
Autoclave/sterilizer ¹	Low				X									
Autoclave/sterilizer ²	High					X								X
Boiler	Low				X									
Boiler	High					X								
Building maintenance sink ³	High		X	X		X						X		X
Carbonated beverage dispenser	High									X				
Cappuccino machine	Low				X					X				
Chemical dispensing system ⁴	High	X	X			X							X	X
Commercial dishwasher	High		X			X								X
Commercial clothes washer	High	X	X			X								X
Commercial overhead hose reel	High					X								
Dental unit/chair ⁵	High					X								X
Espresso machine	Low				X					X				
Exterior wall hydrants	High							X						
Food waste grinder	High		X			X								X
Handheld showers	High		X				X							
Hose threaded outlets ⁶	High			X								X		
Humidifier	Low	X			X									
Kidney dialysis machine	High					X								X
Laboratory sink faucet ⁷	High		X								X	X		
Photo developing machine	High					X								X
Proofing oven	Low				X									
Shampoo/barber sink ⁸	High		X			X	X							X
Swimming pools	High	X	X	X		X		X	X			X		X
Therapeutic pools	High	X	X	X		X		X	X					X
Wading pools	High	X	X	X		X		X	X					X
Water cooled compressors	High					X								X
X-ray developing machine	High					X								X
Yard Hydrants ⁹	High			X								X		

*Any situation may be subject to an alternate approval.

¹ If less than 15pounds steam or 30pounds water, and nontoxic chemicals.

² If greater than 15pounds steam or 30pounds water and/or toxic chemicals.

³ Requires backflow protection even if there is a plain end spout.

⁴ Requires separate water supply terminating without a hose thread or the manufacturer must provide a bleed device in order to connect to the janitor sink faucet spout.

⁵ Or, provide bottled water conversion unit.

⁶ For outlets other than the required ASSE 1019 hydrants.

⁷ If provided with hose threads or serrated nipple.

⁸ Faucet meeting ASME A112.18.1M which includes backflow protection requirements.

⁹ Hydrants that bleed into the ground and/or hydrants that are flush with the grade are prohibited.

A-82.41 (5) (f)-1. CROSS CONNECTION CONTROL ASSEMBLY INSTALLATION.

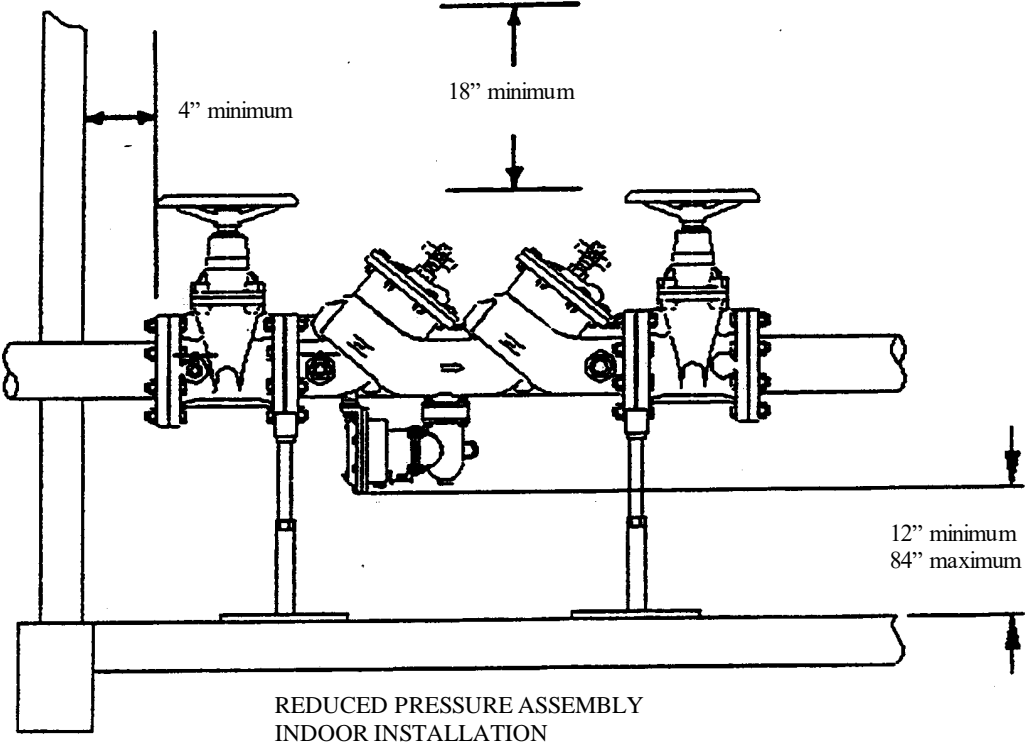
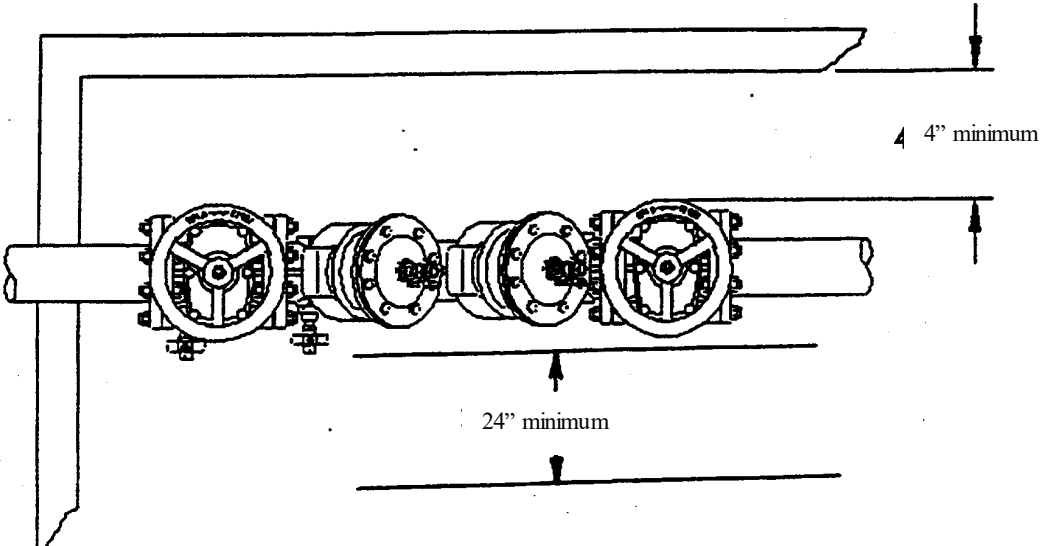

A-82.41 (5) (f)-2. CROSS CONNECTION CONTROL ASSEMBLY INSTALLATION.

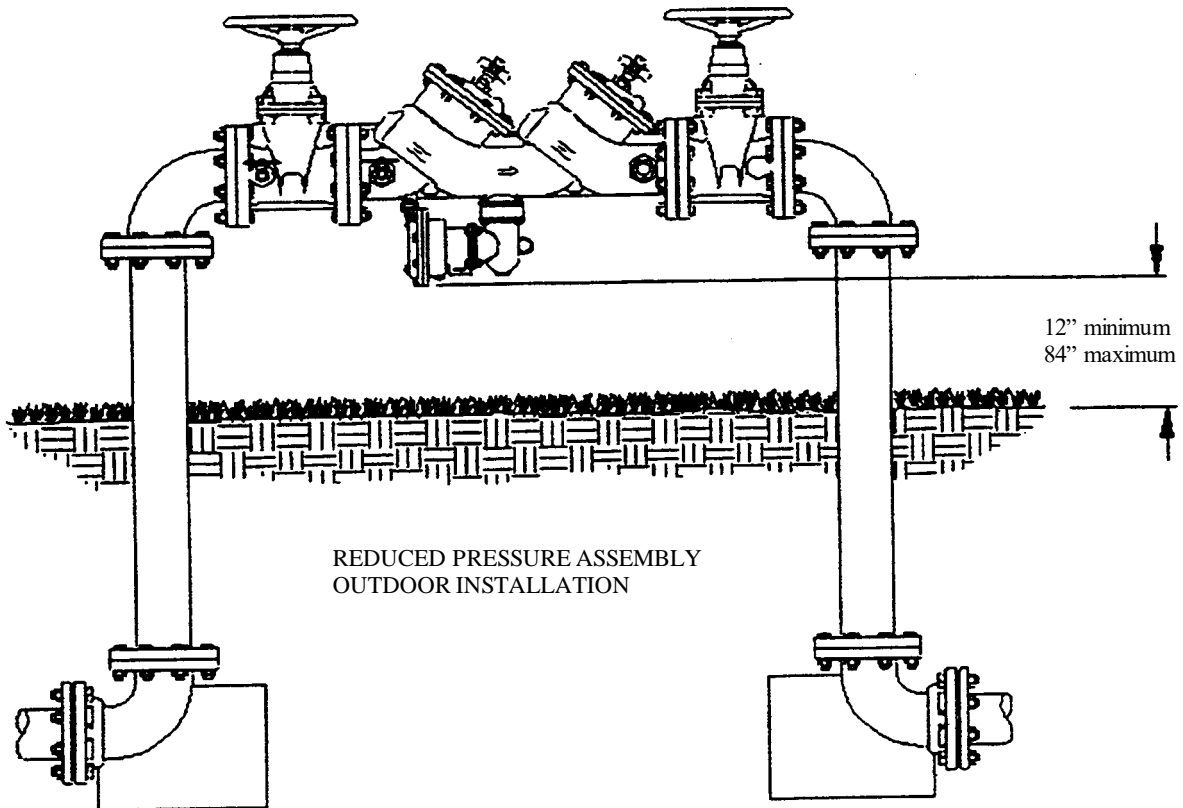
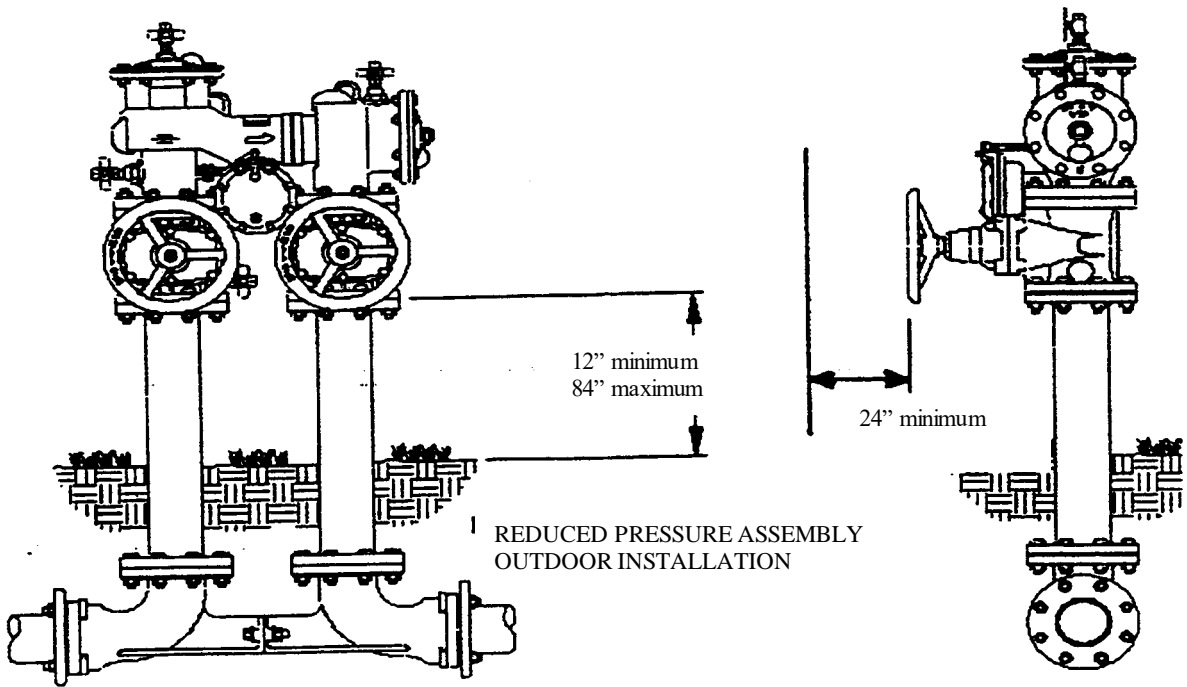

A-82.41 (5) (f)-3. CROSS CONNECTION CONTROL ASSEMBLY INSTALLATION.

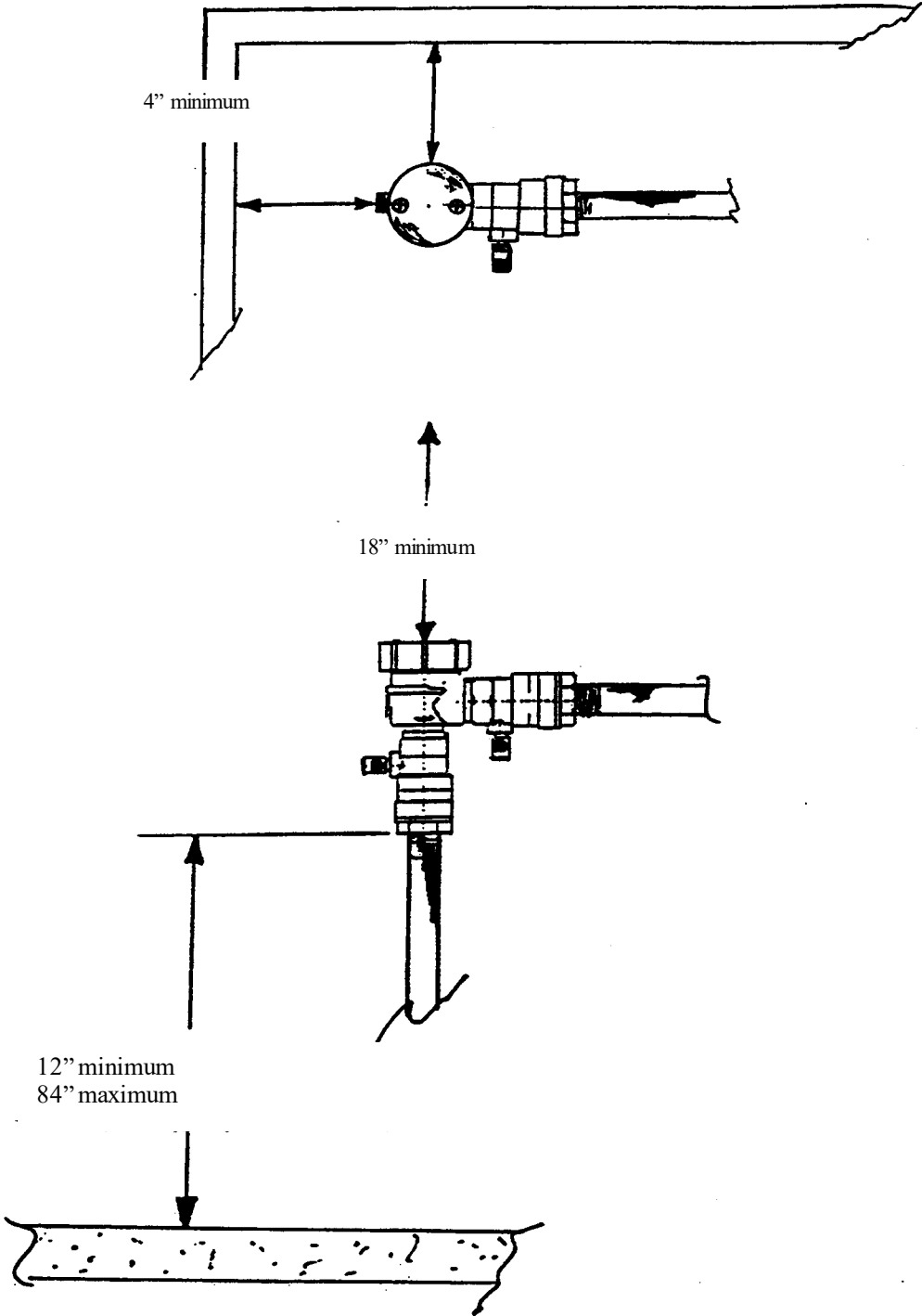

PRESSURE VACUUM BREAKER ASSEMBLY
BACK SIPHONAGE BACKFLOW VACUUM BREAKER

A-82.41 (5) (f)-4. CROSS CONNECTION CONTROL ASSEMBLY INSTALLATION.

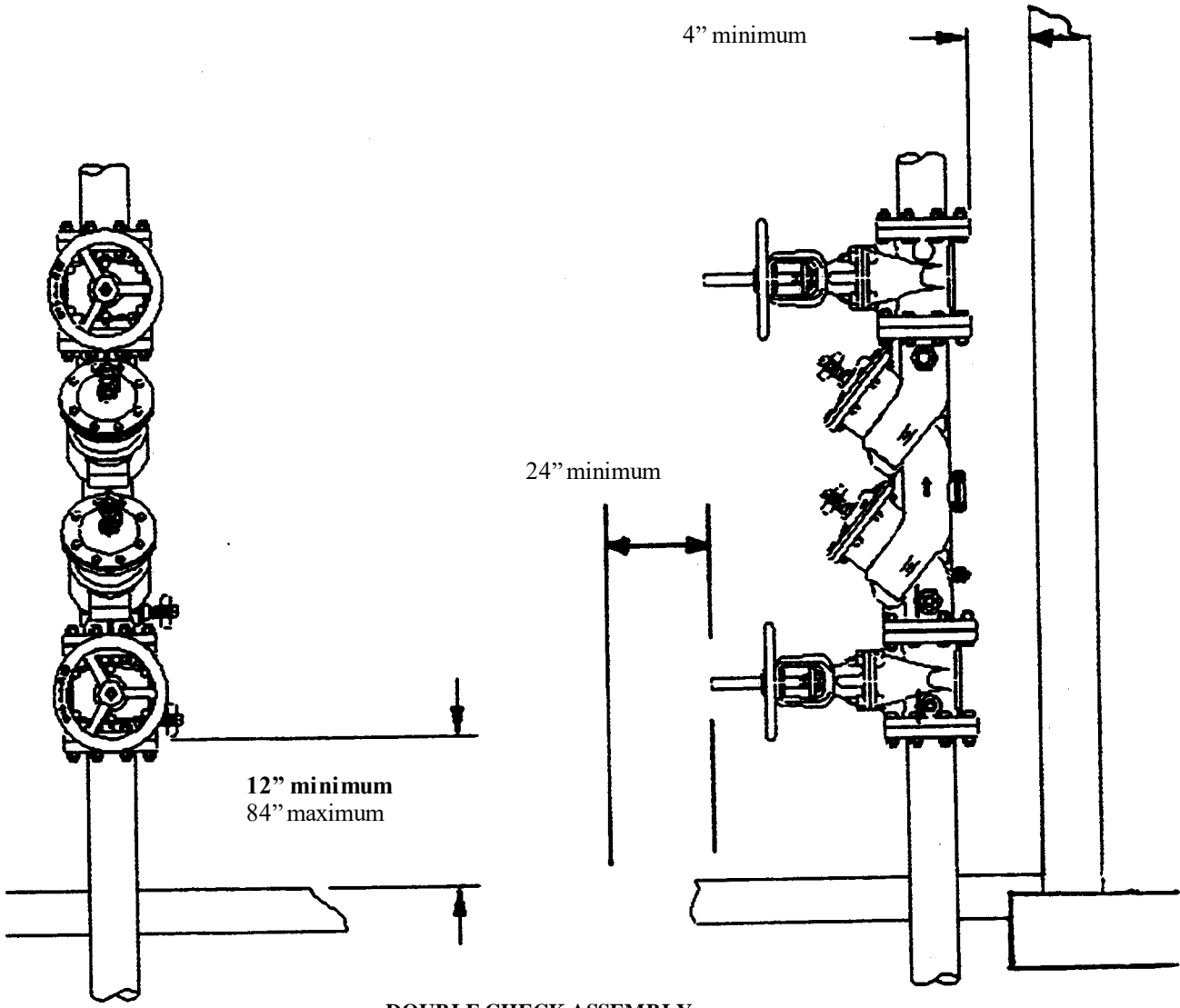

**DOUBLE CHECK ASSEMBLY
INDOOR VERTICAL INSTALLATION**

A-82.41 (5) (f)-5. CROSS CONNECTION CONTROL ASSEMBLY INSTALLATION.

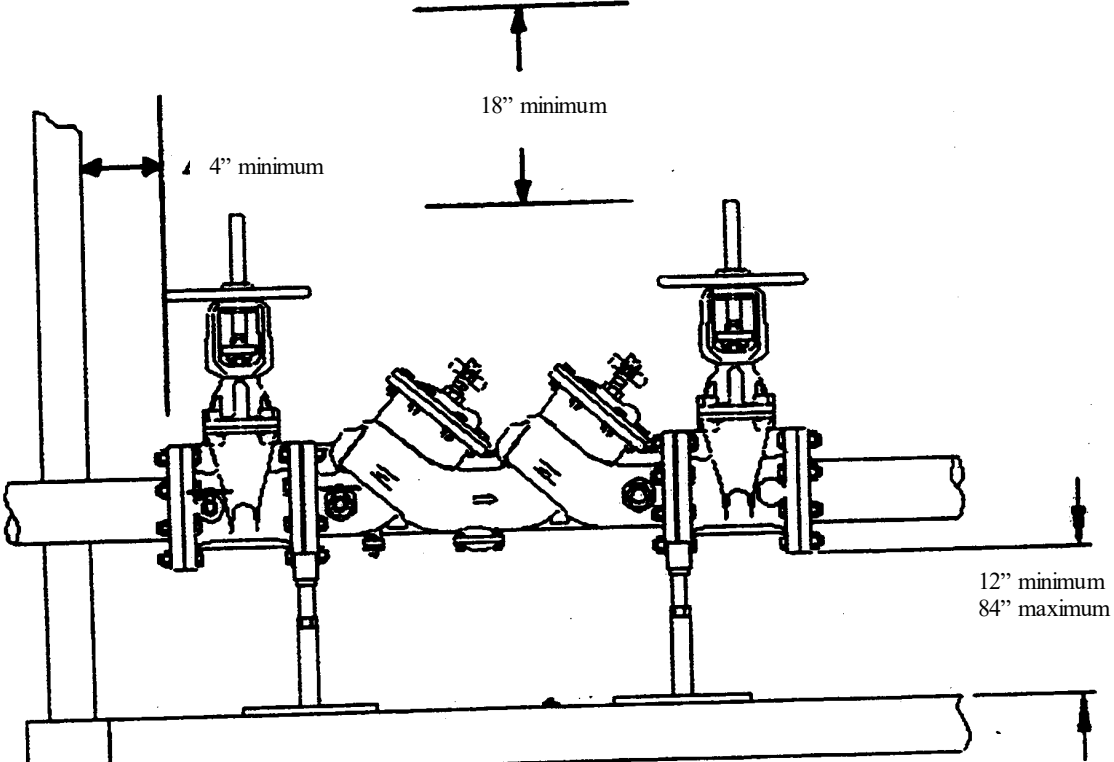
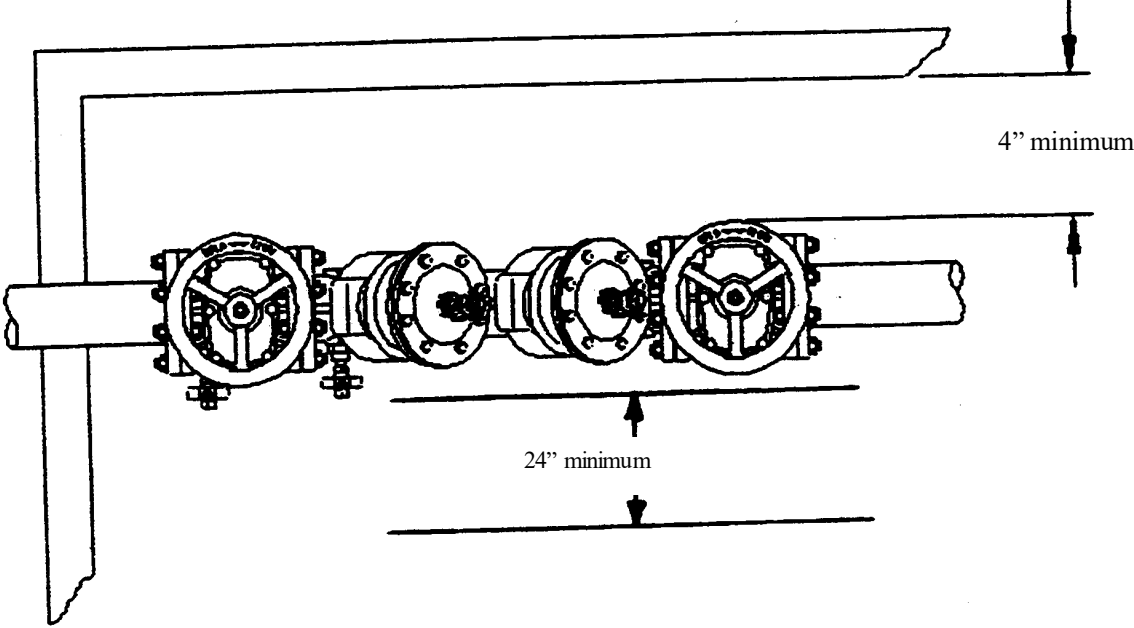

DOUBLE CHECK ASSEMBLY
INDOOR INSTALLATION

A-82.50 (3) (b) 5. OPTIONS FOR TEMPERATURE CONTROL IN HEALTH CARE FACILITIES. The following sketches provide options for fail safe installations at the bathing and shower fixture and temperature control at handwashing fixtures.

Option 1. Fail safe solenoid provided at main mixer meeting ASSE 1017, pressure balanced tub/shower valve meeting ASSE 1016 and limit stop faucets at lavatory and kitchen sink.

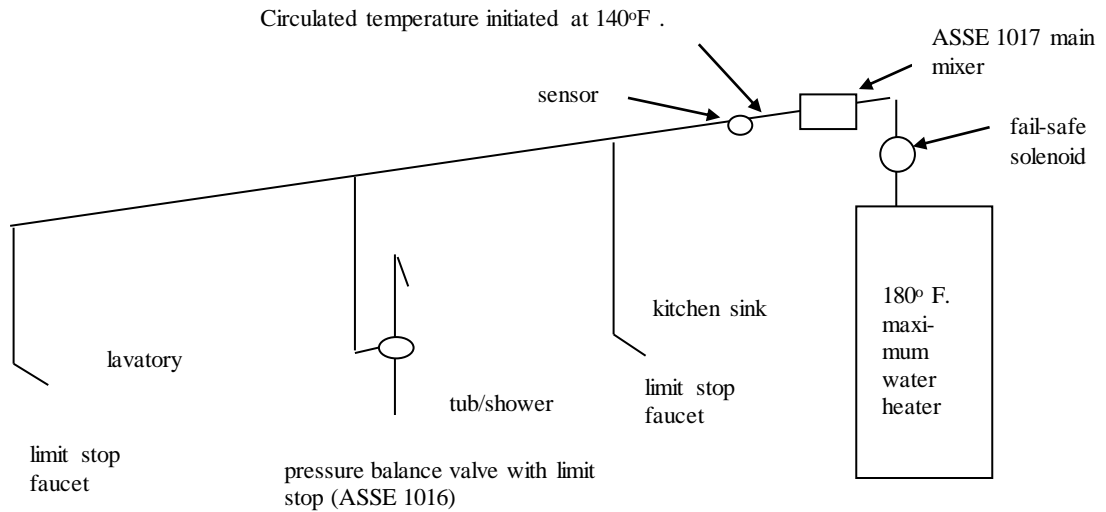

Option 2. Fail safe solenoid provided at main mixer meeting ASSE 1017, pressure balanced tub/shower valve meeting ASSE 1016 and thermostatic mixer meeting ASSE 1016 at lavatory and kitchen sink faucets.

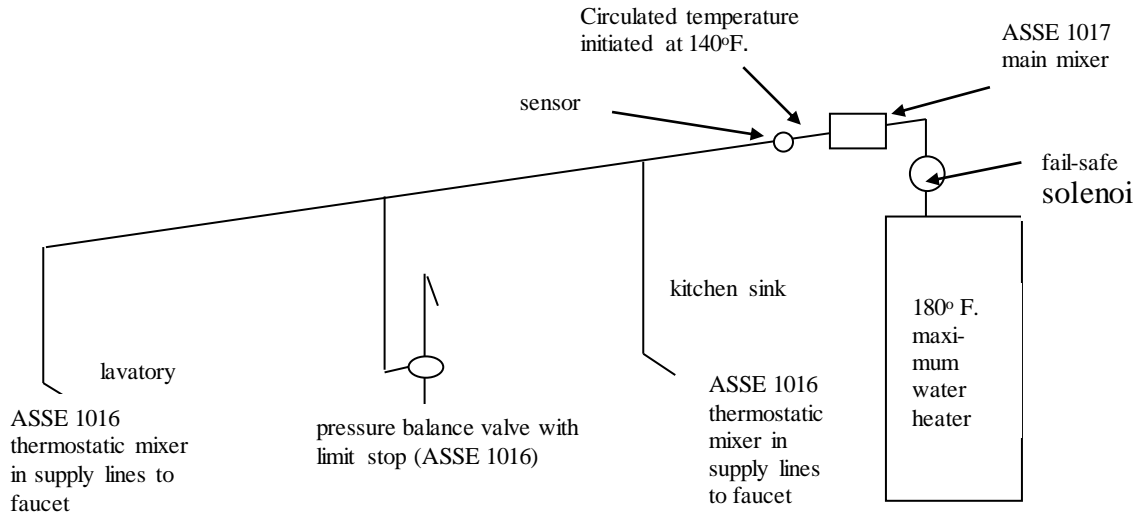

Option 3. Fail safe solenoid provided at main mixer meeting ASSE 1017, thermostatic tub/shower valve meeting ASSE 1016 and limit stop faucets at lavatory and kitchen sink.

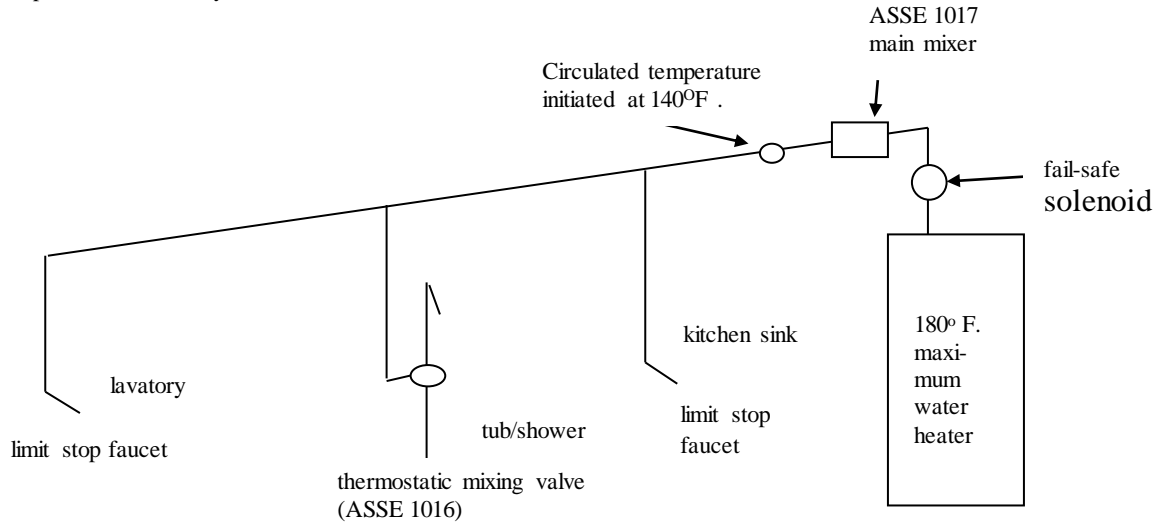

Option 4. Fail safe solenoid provided at main mixer meeting ASSE 1017, combination thermostatic/pressure balance mixing valve meeting ASSE 1016 and limit stop faucets at lavatory and kitchen sink.

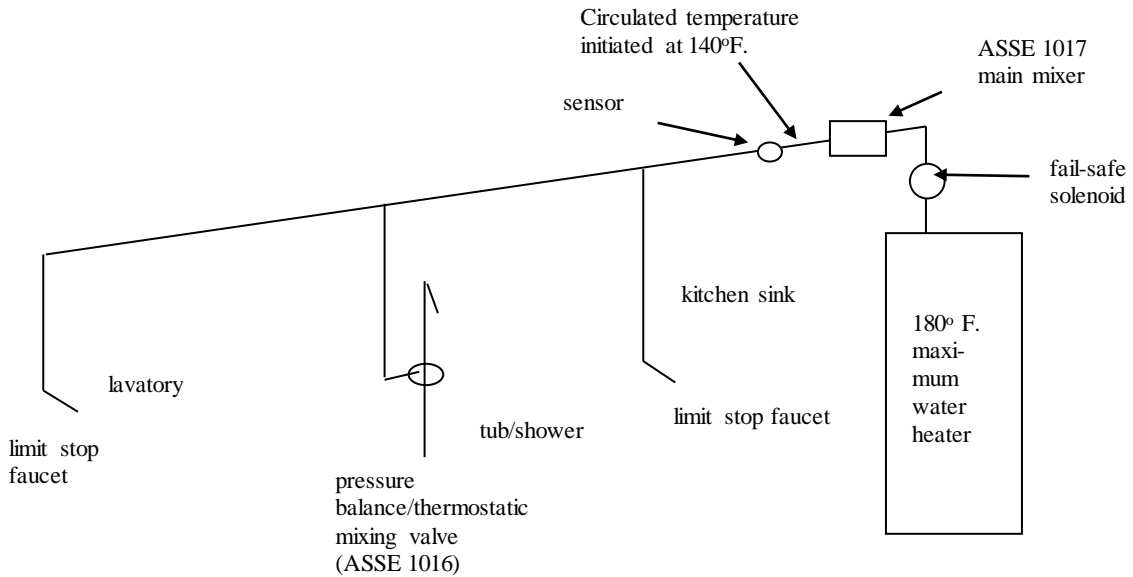

Option 5. Fail safe solenoid, combination pressure balanced/thermostatic tub/shower valve meeting ASSE 1016 and thermostatic mixer meeting ASSE 1016 at lavatory and kitchen sink faucets.

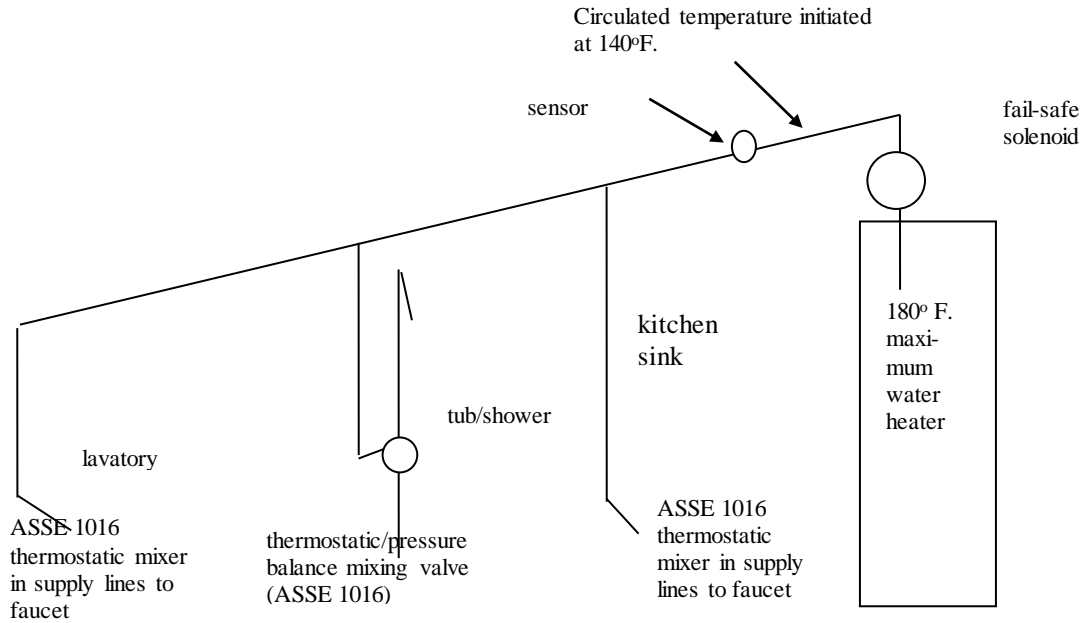

A-82.51 (3) MOBILE HOME SITES AND PARKS. Mobile home building sewer and water service connections.

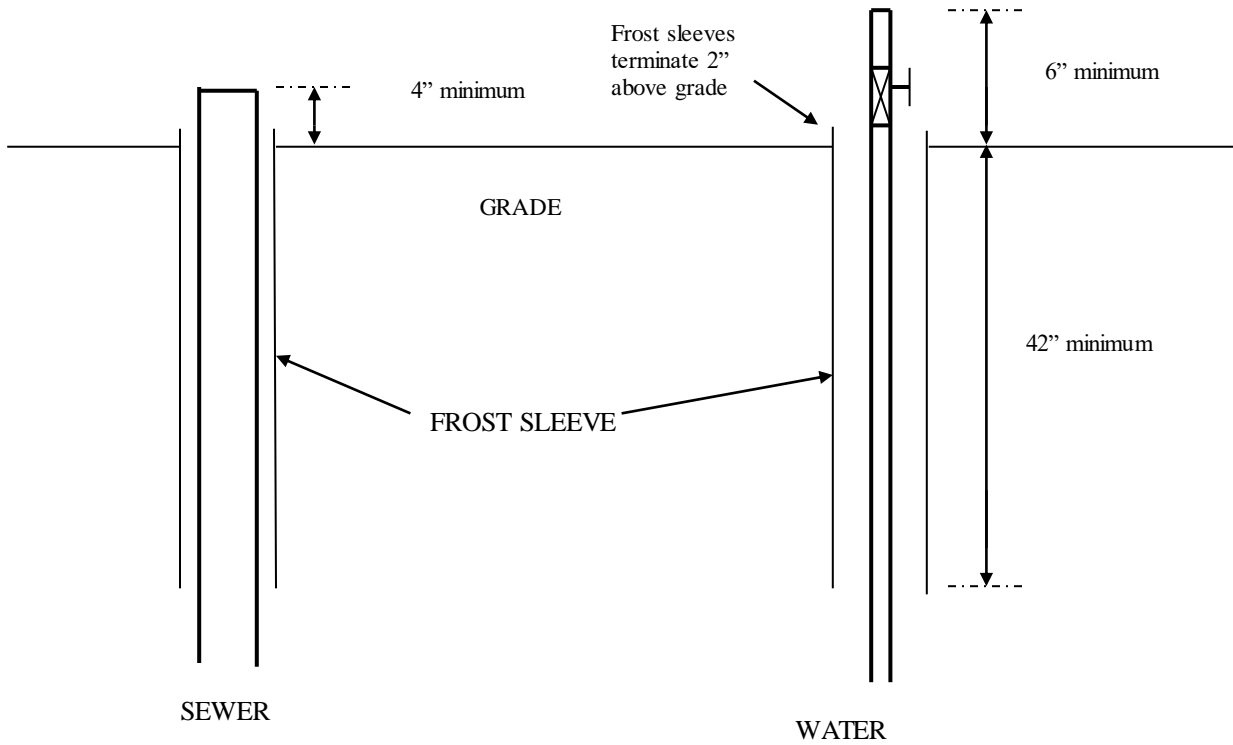

(end)